

ARTESYN AEE 15W-M SERIES

DC/DC Converter



PRODUCT DESCRIPTION

Advanced Energy's Artesyn AEE15W-M series is the new range of high performance DC-DC converter with a reinforced insulation system. I/O- isolation voltage is specified for 4200VACrms. The product comes in a compact 2"x1" industry standard package. All models provide wide 2:1 input voltage range and fully regulated output voltage regulation.

The AEE15W-M series DC/DC converters offer an economical solution for demanding applications in medical instrumentation requesting a certified supplementary or reinforced insulation system to comply with the latest medical safety standards.

SPECIAL FEATURES

- 4200Vac reinforced Insulation
- Insulation rated for 300Vrms working voltage
- Medical safety meets 2xMOPP per 3rd Edition of IEC/EN60601-1&ANSI/AAMI ES60601-1 with CE Marking
- Wide 2:1 input voltage range
- Fully regulated output voltage
- No min. load requirement
- Overload/Voltage and Short Circuit Protection
- Low leakage current <5 μ A
- Operating temperature range -40 °C to +85 °C (with derating)
- Input filter meets EN55011, Class A and FCC, Level A
- Medical EMC Standard meets 4th Edition of EMI EN55011 and EMS EN60601-1-2
- 2"x 1" plastic package
- 3 Years product warranty

SAFETY

- EN/IEC60601-1 3rd Edition, ANSI/AAMI ES60601-1, 2 *MOPP
- CE Mark

TYPICAL APPLICATIONS

- Distributed power architectures
- Workstations
- Computer equipment
- Communications equipment
- Medical equipment

AT A GLANCE

Total Power

15 Watts

Input Voltage

9 to 18 Vdc

18 to 36 Vdc

36 to 75 Vdc

of Outputs

Single / Dual



RoHS

Model Numbers

Model	Input Voltage	Output Voltage	Maximum Load	Efficiency
AEE03A12-M	9 - 18Vdc	5Vdc	3A	86%
AEE01B12-M	9 - 18Vdc	12Vdc	1.25A	89%
AEE01C12-M	9 - 18Vdc	15Vdc	1A	88%
AEE01H12-M	9 - 18Vdc	24Vdc	0.625A	88%
AEE01BB12-M	9 - 18Vdc	±12Vdc	±0.625A	88%
AEE01CC12-M	9 - 18Vdc	±15Vdc	±0.5A	89%
AEE03A24-M	18 - 36Vdc	5Vdc	3A	88%
AEE01B24-M	18 - 36Vdc	12Vdc	1.25A	89%
AEE01C24-M	18 - 36Vdc	15Vdc	1A	89%
AEE01H24-M	18 - 36Vdc	24Vdc	0.625A	90%
AEE01BB24-M	18 - 36Vdc	±12Vdc	±0.625A	90%
AEE01CC24-M	18 - 36Vdc	±15Vdc	±0.5A	89%
AEE03A48-M	36 - 75Vdc	5Vdc	3A	88%
AEE01B48-M	36 - 75Vdc	12Vdc	1.25A	88%
AEE01C48-M	36 - 75Vdc	15Vdc	1A	90%
AEE01H48-M	36 - 75Vdc	24Vdc	0.625A	89%
AEE01BB48-M	36 - 75Vdc	±12Vdc	±0.625A	89%
AEE01CC48-M	36 - 75Vdc	±15Vdc	±0.5A	88%

Options

None

Electrical Specifications

Absolute Maximum Ratings

Stress in excess of those listed in the “Absolute Maximum Ratings” may cause permanent damage to the power supply. These are stress ratings only and functional operation of the unit is not implied at these or any other conditions above those given in the operational sections of this TRN. Exposure to any absolute maximum rated condition for extended periods may adversely affect the power supply’s reliability.

Table 1. Absolute Maximum Ratings						
Parameter	Model	Symbol	Min	Typ	Max	Unit
Input Surge Voltage 100mSec. max	12V Input Models	$V_{IN,DC}$	-0.7	-	25	Vdc
	24V Input Models		-0.7	-	50	Vdc
	48V Input Models		-0.7	-	100	Vdc
Maximum Output Power	All Models	$P_{O,max}$	-	-	15	W
Isolation Voltage Input to Output (60 seconds)	All Models		4200	-	-	Vac
Isolation Resistance (500Vdc)	All Models		10	-	-	Gohm
Isolation Capacitance (100KHz,1V)	All Models		-	-	80	pF
Thermal Impedance	Natural Convection		13	-	-	°C/W
Operating Ambient Temperature Range	Natural Convection		-40		+80 ¹	°C
Operating Case Temperature	All Models	T_{CASE}	-	-	+95	°C
Storage Temperature	All Models	T_{STG}	-50		+125	°C
Humidity (non-condensing)	All Models		-	-	95	%
			Operating	-	-	95
MTBF	MIL-HDBK-217F@25°C, Ground Benign		1000000	-	-	Hours

Note 1 - With Derating

Electrical Specifications

Input Specifications

Table 2. Input Specifications							
Parameter		Condition	Symbol	Min	Typ	Max	Unit
Operating Input Voltage, DC	12V Input Models	All	$V_{IN,DC}$	9	12	18	Vdc
	24V Input Models			18	24	36	
	48V Input Models			36	48	75	
Start-Up Threshold Voltage	12V Input Models	All	$V_{IN,ON}$	-	-	9	Vdc
	24V Input Models			-	-	18	
	48V Input Models			-	-	36	
Under Voltage Lockout	12V Input Models	All	$V_{IN,OFF}$	-	7.5	-	Vdc
	24V Input Models			-	15	-	
	48V Input Models			-	33	-	
Input reflected ripple current	12V Input Models	0 to 500KHz, $L_{in}=4.7\mu H$ $C_{in}=220\mu F$, ESR < 1.0 Ω at 100 KHz	$I_{IN,ripple}$	-	100	-	mA
	24V Input Models			-	50	-	
	48V Input Models			-	30	-	
Input Current	AEE03A12-M	$V_{IN,DC}=V_{IN,nom}$ $I_O=I_{O,max}$	I_{IN,max_load}	-	1453	-	mA
	AEE01B12-M			-	1404	-	
	AEE01C12-M			-	1420	-	
	AEE01H12-M			-	1420	-	
	AEE01BB12-M			-	1420	-	
	AEE01CC12-M			-	1404	-	
	AEE03A24-M			-	710	-	
	AEE01B24-M			-	702	-	
	AEE01C24-M			-	702	-	
	AEE01H24-M			-	694	-	
	AEE01BB24-M			-	694	-	
	AEE01CC24-M			-	702	-	
	AEE03A48-M			-	355	-	
	AEE01B48-M			-	355	-	
	AEE01C48-M			-	347	-	
AEE01H48-M	-	351	-				
AEE01BB48-M	-	351	-				
AEE01CC48-M	-	355	-				
No Load Input Current (V_O On, $I_O = 0A$)	12V Input Models	$V_{IN,DC}=V_{IN,nom}$	I_{IN,no_load}	-	20	-	mA
	24V Input Models			-	15	-	
	48V Input Models			-	10	-	

Electrical Specifications

Input Specifications

Table 2. Input Specifications con't							
Parameter		Condition	Symbol	Min	Typ	Max	Unit
Efficiency @Max. Load	AEE03A12-M	$V_{IN,DC}=V_{IN,nom}$ $I_O=I_{O,max}$ $T_A=25^{\circ}C$	η	-	86	-	%
	AEE01B12-M			-	89	-	
	AEE01C12-M			-	88	-	
	AEE01H12-M			-	88	-	
	AEE01BB12-M			-	88	-	
	AEE01CC12-M			-	89	-	
	AEE03A24-M			-	88	-	
	AEE01B24-M			-	89	-	
	AEE01C24-M			-	89	-	
	AEE01H24-M			-	90	-	
	AEE01BB24-M			-	90	-	
	AEE01CC24-M			-	89	-	
	AEE03A48-M			-	88	-	
	AEE01B48-M			-	88	-	
	AEE01C48-M			-	90	-	
	AEE01H48-M			-	89	-	
AEE01BB48-M	-	89	-				
AEE01CC48-M	-	88	-				
Leakage Current	All Models	$V_{IN,AC}=240Vac$ $f_{IN}=60Hz$	$I_{IN,Leakage}$	-	-	5	μA
Internal Filter Type		All		Internal Pi Type			

Electrical Specifications

Output Specifications

Table 3. Output Specifications							
Parameter		Condition	Symbol	Min	Typ	Max	Unit
Output Voltage Set-Point	AEE03A12-M	$V_{IN,DC}=V_{IN,nom}$ $I_O=I_{O,max}$ $T_A=25^{\circ}C$	V_O	4.95	5	5.05	Vdc
	AEE01B12-M			11.88	12	12.12	
	AEE01C12-M			14.85	15	15.15	
	AEE01H12-M			23.76	24	24.24	
	AEE01BB12-M			± 11.88	± 12	± 12.12	
	AEE01CC12-M			± 14.85	± 15	± 15.15	
	AEE03A24-M			4.95	5	5.05	
	AEE01B24-M			11.88	12	12.12	
	AEE01C24-M			14.85	15	15.15	
	AEE01H24-M			23.76	24	24.24	
	AEE01BB24-M			± 11.88	± 12	± 12.12	
	AEE01CC24-M			± 14.85	± 15	± 15.15	
	AEE03A48-M			4.95	5	5.05	
	AEE01B48-M			11.88	12	12.12	
	AEE01C48-M			14.85	15	15.15	
	AEE01H48-M			23.76	24	24.24	
	AEE01BB48-M			± 11.88	± 12	± 12.12	
AEE01CC48-M	± 14.85	± 15	± 15.15				
Output Voltage Balance	Dual Output, Balanced Loads	All	$\pm\%V_O$	-	-	2.0	%
Output Current	AEE03A12-M	Natural Convection	I_O	-	-	3	A
	AEE01B12-M			-	-	1.25	
	AEE01C12-M			-	-	1	
	AEE01H12-M			-	-	0.625	
	AEE01BB12-M			-	-	± 0.625	
	AEE01CC12-M			-	-	± 0.5	
	AEE03A24-M			-	-	3	
	AEE01B24-M			-	-	1.25	
	AEE01C24-M			-	-	1	
	AEE01H24-M			-	-	0.625	
	AEE01BB24-M			-	-	± 0.625	
	AEE01CC24-M			-	-	± 0.5	
	AEE03A48-M			-	-	3	
	AEE01B48-M			-	-	1.25	
	AEE01C48-M			-	-	1	
	AEE01H48-M			-	-	0.625	
	AEE01BB48-M			-	-	± 0.625	
AEE01CC48-M	-	-	± 0.5				

Electrical Specifications

Output Specifications

Table 3. Output Specifications Con't							
Parameter		Condition	Symbol	Min	Nom	Max	Unit
V _O Load Capacitance	AEE03A12-M	All	C _O	-	-	5100	uF
	AEE01B12-M			-	-	870	
	AEE01C12-M			-	-	560	
	AEE01H12-M			-	-	220	
	AEE01BB12-M			-	-	4401	
	AEE01CC12-M			-	-	2801	
	AEE03A24-M			-	-	5100	
	AEE01B24-M			-	-	870	
	AEE01C24-M			-	-	560	
	AEE01H24-M			-	-	220	
	AEE01BB24-M			-	-	4401	
	AEE01CC24-M			-	-	2801	
	AEE03A48-M			-	-	5100	
	AEE01B48-M			-	-	870	
	AEE01C48-M			-	-	560	
	AEE01H48-M			-	-	220	
AEE01BB48-M	-	-	4401				
AEE01CC48-M	-	-	2801				
Start Up Time (Power On)	All Models	V _{IN,DC} =V _{IN,nom} I _O =I _{O,max} Resistive Load	T _{Turn-On}	-	-	30	mSec
Line Regulation	All Models	V _{IN,DC} =V _{IN,min} to V _{IN,max} I _O =I _{O,max}	±%V _O	-	-	0.5	%
Load Regulation	Single Output	I _O =I _{O,min} to I _{O,max}	±%V _O	-	-	0.5	%
	Dual Output			-	-	1.0	
Switching Frequency	All Models	All	f _{sw}	-	285	-	KHz
V _O Dynamic Response	Peak Deviation Settling Time	25% load change	±%V _O t _s	-	±3	±5	%
				-	-	300	uSec
Temperature Coefficient		All	%/°C	-0.02	-	0.02	%
Output Over Current Protection ²		All	%I _{O,max}	-	150	-	%
Output Short Circuit Protection ³		All		Hiccup Automatic Recovery			

Note 1 - For each output

Note 2 - Hiccup Automatic Recovery

Note 3 - Hiccup Mode 0.7Hz typ., Automatic Recovery

Electrical Specifications

Output Specifications

Table 3. Output Specifications Con't							
Parameter		Condition	Symbol	Min	Typ	Max	Unit
Output Over Voltage Protection	AEE03A12-M	All		-	6.2	-	Vdc
	AEE01B12-M			-	15	-	
	AEE01C12-M			-	18	-	
	AEE01H12-M			-	27	-	
	AEE01BB12-M			-	±15	-	
	AEE01CC12-M			-	±18	-	
	AEE03A24-M			-	6.2	-	
	AEE01B24-M			-	15	-	
	AEE01C24-M			-	18	-	
	AEE01H24-M			-	27	-	
	AEE01BB24-M			-	±15	-	
	AEE01CC24-M			-	±18	-	
	AEE03A48-M			-	6.2	-	
	AEE01B48-M			-	15	-	
	AEE01C48-M			-	18	-	
	AEE01H48-M			-	27	-	
AEE01BB48-M	-	±15	-				
AEE01CC48-M	-	±18	-				
Output Ripple, pk-pk	AEE03A12-M	Measure with a 4.7uF ceramic capacitor in parallel with a 10uF tantalum capacitor, 0 to 20MHz bandwidth	V _O	-	50	-	mV _{PK-PK}
	AEE03A24-M			-	50	-	
	AEE03A48-M			-	50	-	
	AEE01B12-M			-	100	-	
	AEE01C12-M			-	100	-	
	AEE01BB12-M			-	100	-	
	AEE01CC12-M			-	100	-	
	AEE01B24-M			-	100	-	
	AEE01C24-M			-	100	-	
	AEE01BB24-M			-	100	-	
	AEE01CC24-M			-	100	-	
	AEE01B48-M			-	100	-	
	AEE01C48-M			-	100	-	
	AEE01BB48-M			-	100	-	
	AEE01CC48-M			-	100	-	
AEE01H12-M	-	150	-				
AEE01H24-M	-	150	-				
AEE01H48-M	-	150	-				

Electrical Specifications

AEE03A12-M Performance Curves

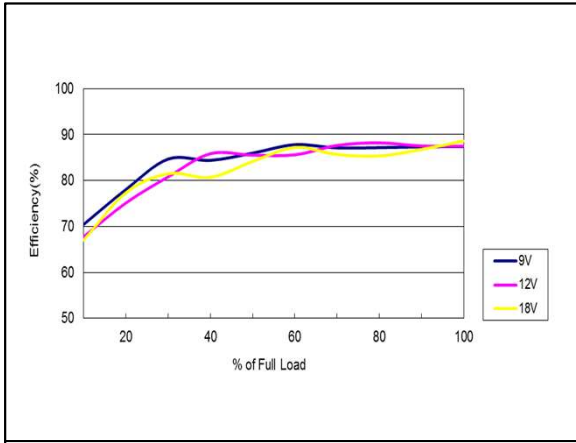

Figure 1: AEE03A12-M Efficiency Versus Output Current Curve
 Vin = 9 to 18Vdc Load: Io = 0 to 3A Ta = 25°C

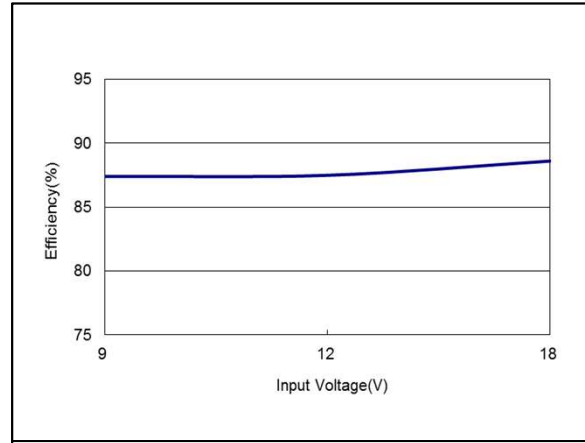

Figure 2: AEE03A12-M Efficiency Versus Input Voltage Curve
 Vin = 9 to 18Vdc Load: Io = 3A Ta = 25°C

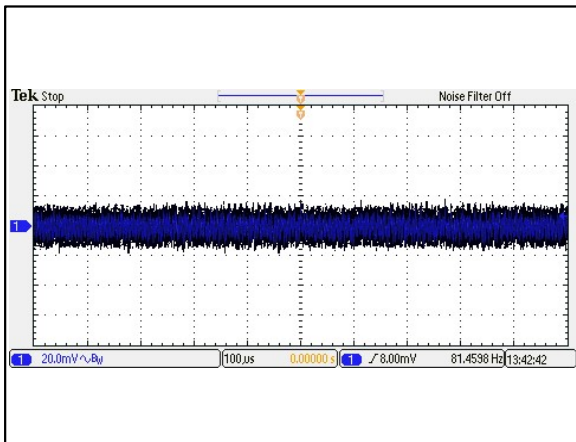

Figure 3: AEE03A12-M Ripple and Noise Measurement
 Vin = 12Vdc Load: Io = 3A Ta = 25°C
 Ch 1: Vo

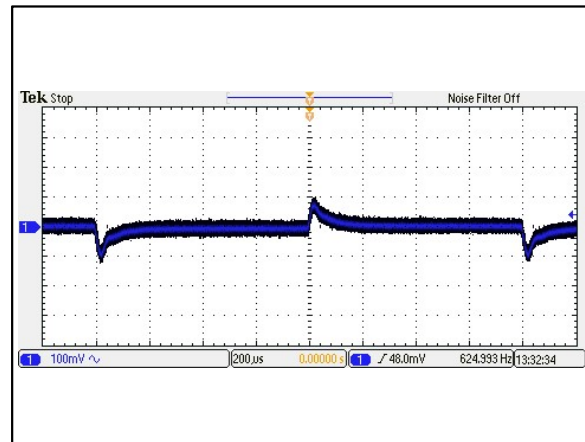

Figure 4: AEE03A12-M Transient Response
 Vin = 12Vdc Load: Io = 100% to 75% load change Ta = 25°C
 Ch 1: Vo

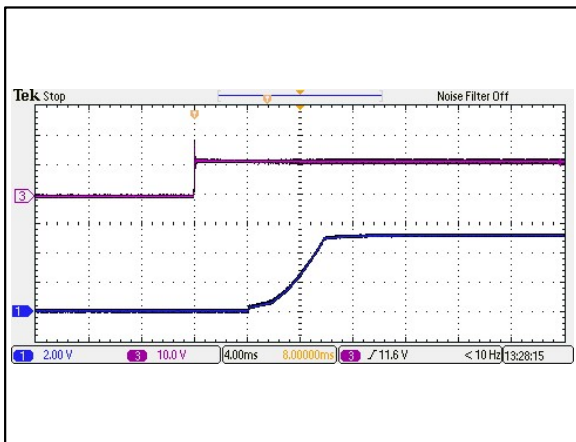

Figure 5: AEE03A12-M Output Voltage Startup Characteristic by Vin
 Vin = 12Vdc Load: Io = 3A Ta = 25°C
 Ch 1: Vo Ch 3: Vin

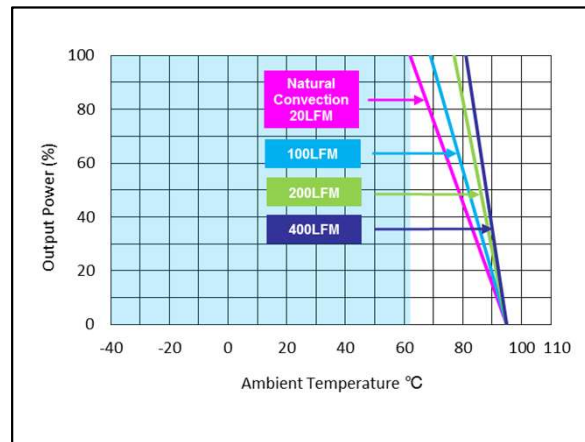

Figure 6: AEE03A12-M Derating Curve (without heatsink).
 Vin = 12Vdc Load: Io = 0 to 3A Ta = 25°C

Electrical Specifications

AEE01B12-M Performance Curves

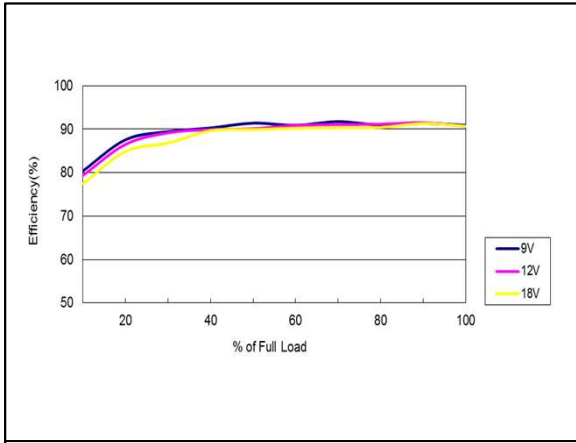

Figure 7: AEE01B12-M Efficiency Versus Output Current Curve
 Vin = 9 to 18Vdc Load: Io = 0 to 1.25A Ta = 25°C

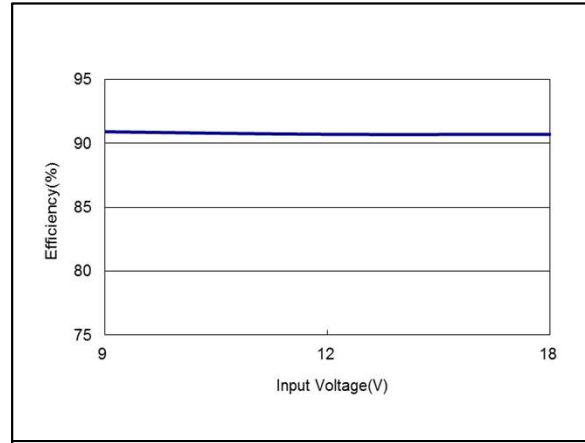

Figure 8: AEE01B12-M Efficiency Versus Input Voltage Curve
 Vin = 9 to 18Vdc Load: Io = 1.25A Ta = 25°C

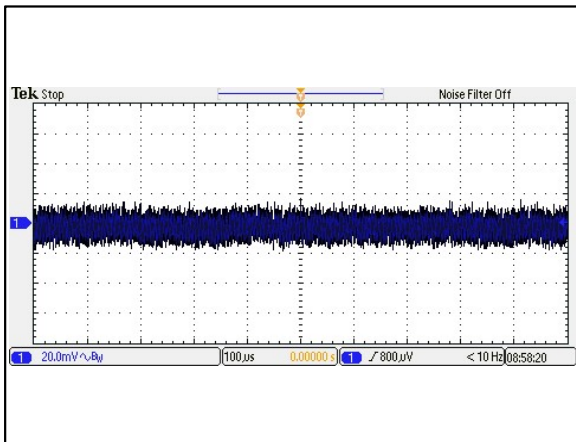

Figure 9: AEE01B12-M Ripple and Noise Measurement
 Vin = 12Vdc Load: Io = 1.25A Ta = 25°C
 Ch 1: Vo

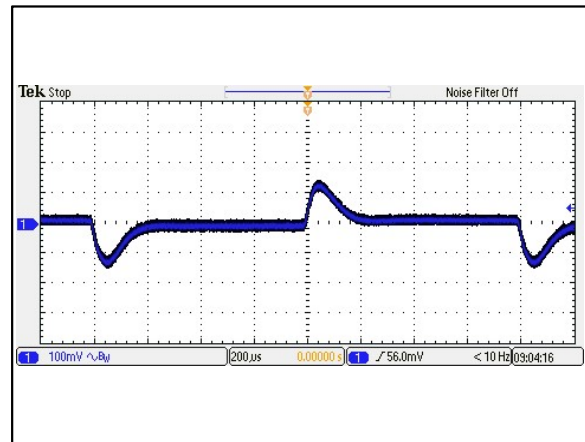

Figure 10: AEE01B12-M Transient Response
 Vin = 12Vdc Load: Io = 100% to 75% load change Ta = 25°C
 Ch 1: Vo

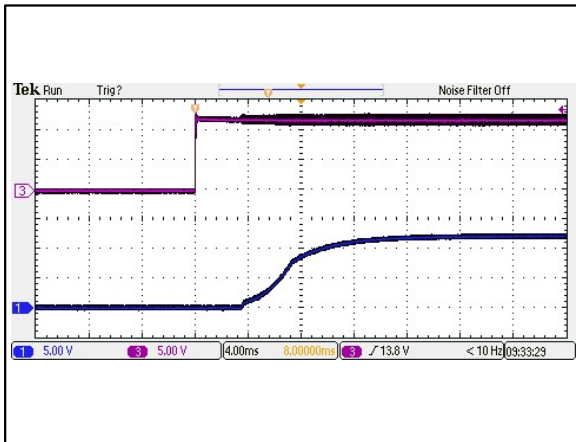

Figure 11: AEE01B12-M Output Voltage Startup Characteristic by Vin
 Vin = 12Vdc Load: Io = 1.25A Ta = 25°C
 Ch 1: Vo Ch 3: Vin

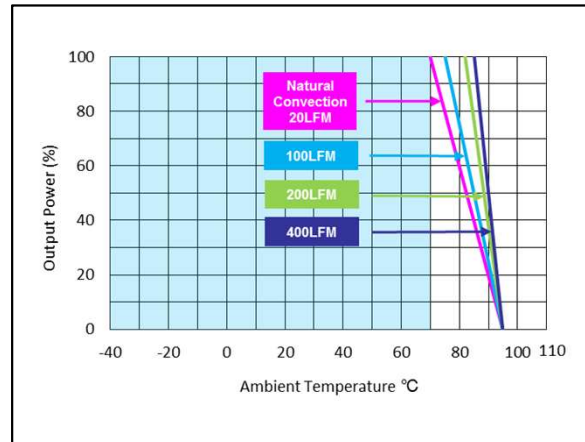

Figure 12: AEE01B12-M Derating Curve (without heatsink).
 Vin = 12Vdc Load: Io = 0 to 1.25A Ta = 25°C

Electrical Specifications

AEE01C12-M Performance Curves

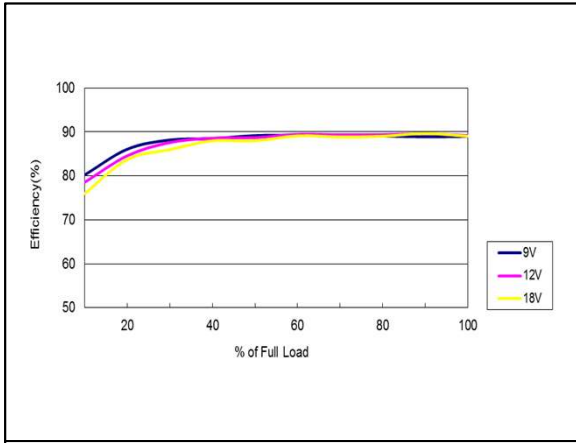

Figure 13: AEE01C12-M Efficiency Versus Output Current Curve
 Vin = 9 to 18Vdc Load: Io = 0 to 1A Ta = 25°C

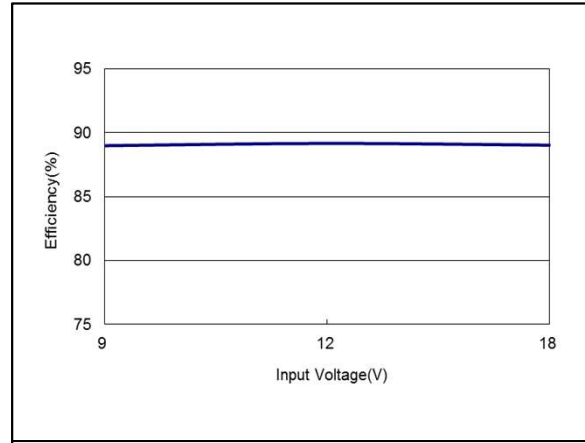

Figure 14: AEE01C12-M Efficiency Versus Input Voltage Curve
 Vin = 9 to 18Vdc Load: Io = 1A Ta = 25°C

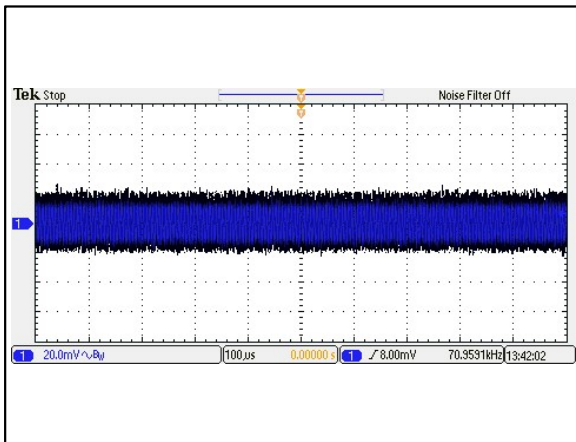

Figure 15: AEE01C12-M Ripple and Noise Measurement
 Vin = 12Vdc Load: Io = 1A Ta = 25°C
 Ch 1: Vo

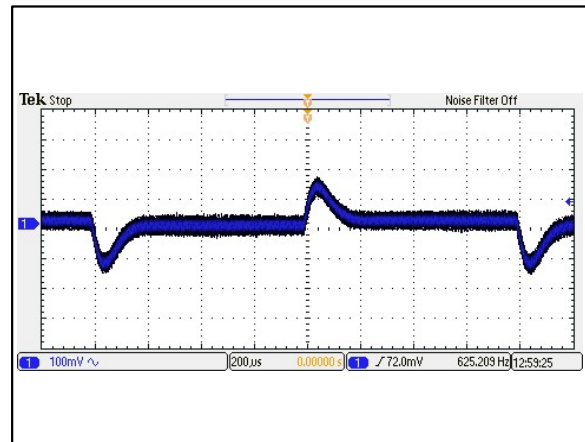

Figure 16: AEE01C12-M Transient Response
 Vin = 12Vdc Load: Io = 100% to 75% load change Ta = 25°C
 Ch 1: Vo

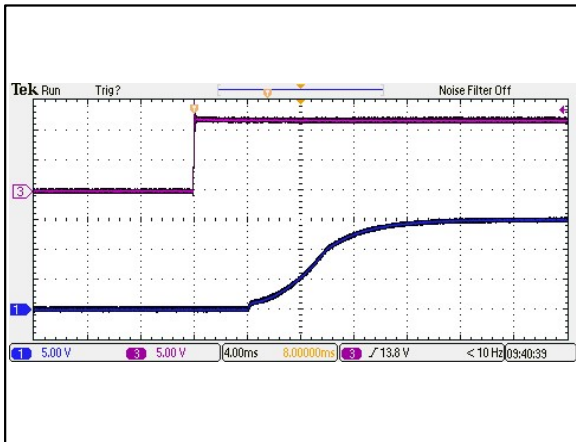

Figure 17: AEE01C12-M Output Voltage Startup Characteristic by Vin
 Vin = 12Vdc Load: Io = 1A Ta = 25°C
 Ch 1: Vo Ch 3: Vin

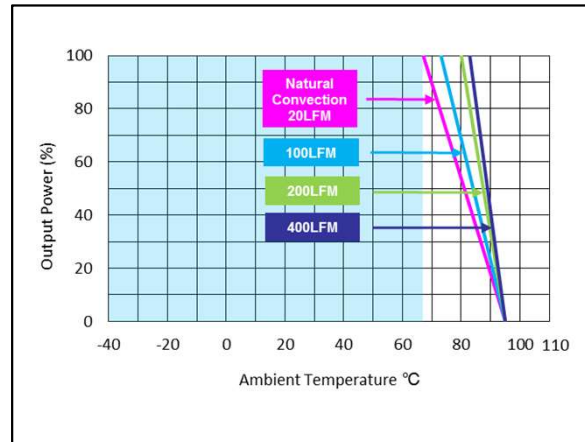

Figure 18: AEE01C12-M Derating Curve (without heatsink).
 Vin = 12Vdc Load: Io = 0 to 1A Ta = 25°C

Electrical Specifications

AEE01H12-M Performance Curves

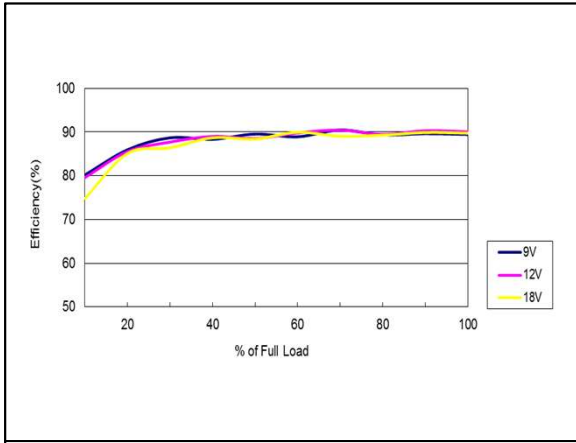

Figure 19: AEE01H12-M Efficiency Versus Output Current Curve
 Vin = 9 to 18Vdc Load: Io = 0 to 0.625A Ta = 25°C

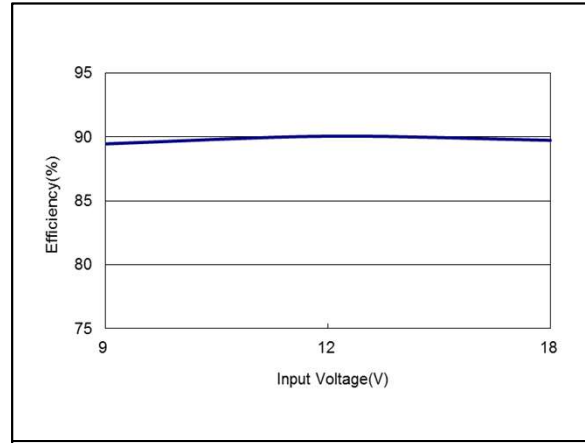

Figure 20: AEE01H12-M Efficiency Versus Input Voltage Curve
 Vin = 9 to 18Vdc Load: Io = 0.625A Ta = 25°C

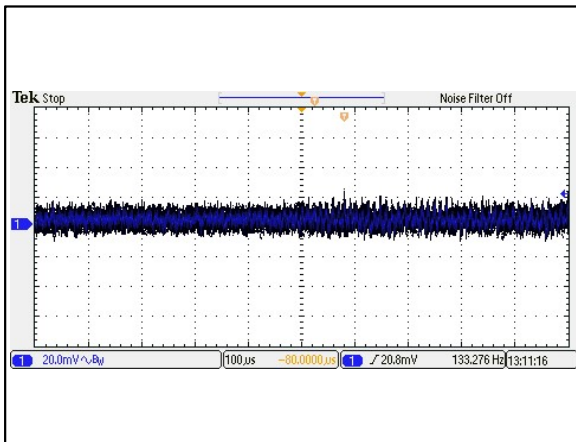

Figure 21: AEE01H12-M Ripple and Noise Measurement
 Vin = 12Vdc Load: Io = 0.625A Ta = 25°C
 Ch 1: Vo

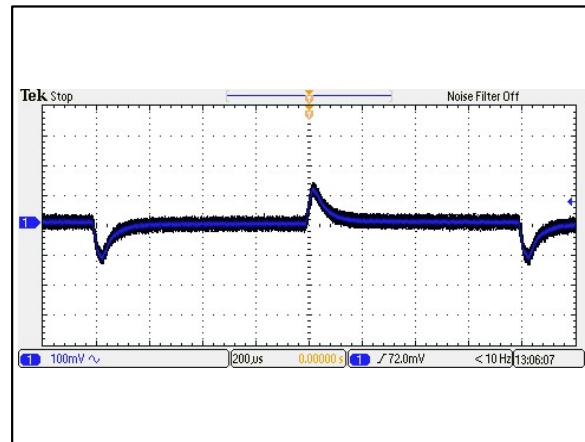

Figure 22: AEE01H12-M Transient Response
 Vin = 12Vdc Load: Io = 100% to 75% load change Ta = 25°C
 Ch 1: Vo

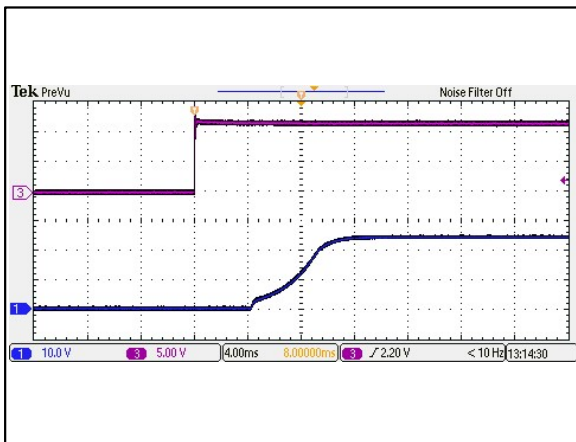

Figure 23: AEE01H12-M Output Voltage Startup Characteristic by Vin
 Vin = 12Vdc Load: Io = 0.625A Ta = 25°C
 Ch 1: Vo Ch 3: Vin

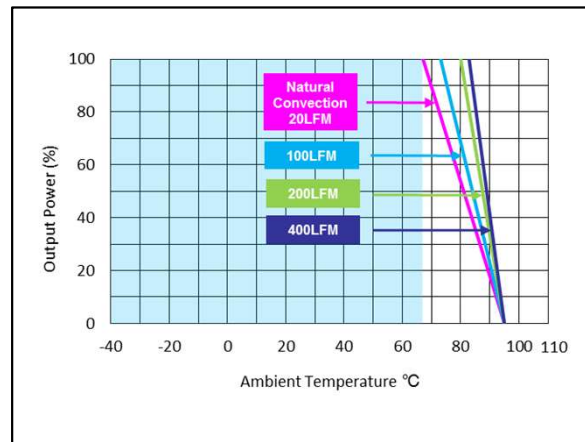

Figure 24: AEE01H12-M Derating Curve (without heatsink).
 Vin = 12Vdc Load: Io = 0 to 0.625A Ta = 25°C

Electrical Specifications

AEE01BB12-M Performance Curves

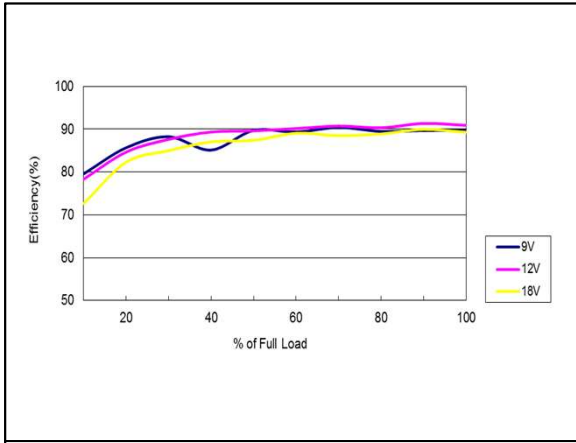

Figure 25: AEE01BB12-M Efficiency Versus Output Current Curve
 Vin = 9 to 18Vdc Load: Io = 0 to ±0.625A Ta = 25°C

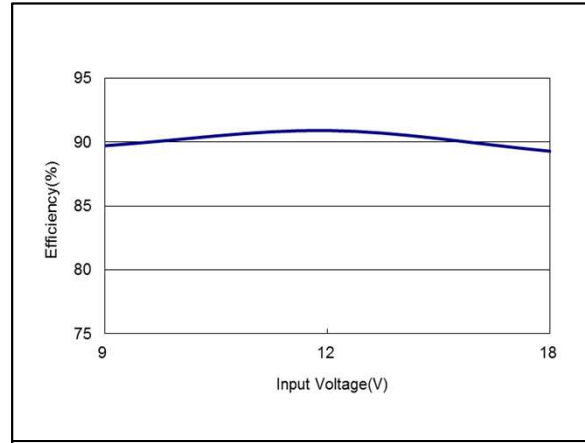

Figure 26: AEE01BB12-M Efficiency Versus Input Voltage Curve
 Vin = 9 to 18Vdc Load: Io = ±0.625A Ta = 25°C

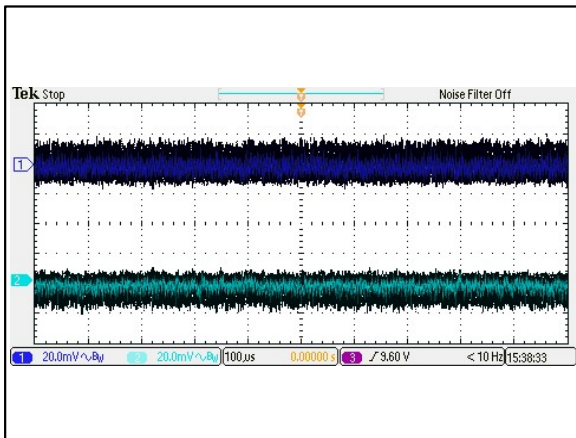

Figure 27: AEE01BB12-M Ripple and Noise Measurement
 Vin = 12Vdc Load: Io = ±0.625A Ta = 25°C
 Ch 1: Vo1 Ch 2: Vo2

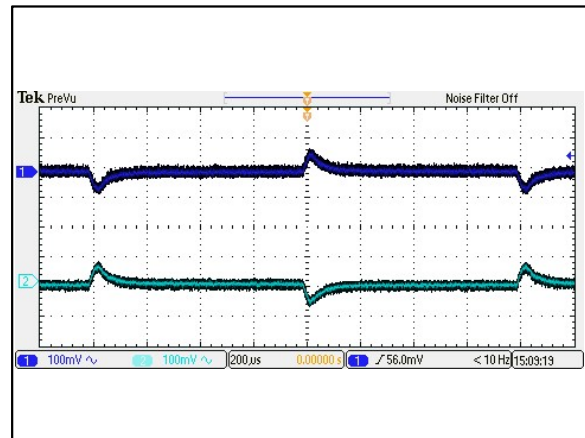

Figure 28: AEE01BB12-M Transient Response
 Vin = 12Vdc Load: Io = 100% to 75% load change Ta = 25°C
 Ch 1: Vo1 Ch 2: Vo2

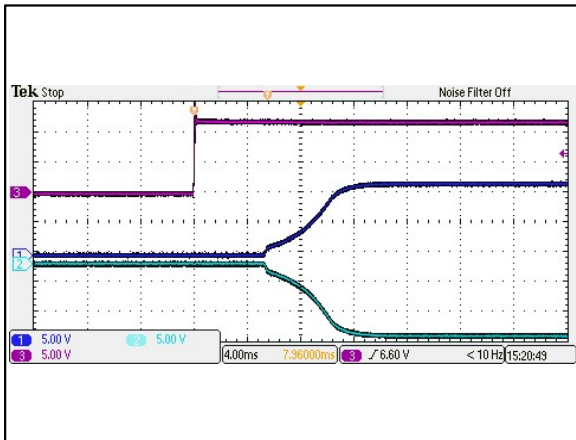

Figure 29: AEE01BB12-M Output Voltage Startup Characteristic by Vin
 Vin = 12Vdc Load: Io = ±0.625A Ta = 25°C
 Ch 1: Vo1 Ch 2: Vo2 Ch 3: Vin

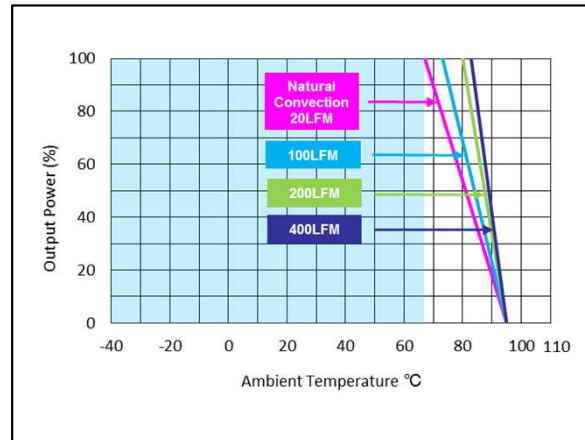

Figure 30: AEE01BB12-M Derating Curve (without heatsink).
 Vin = 12Vdc Load: Io = 0 to ±0.625A Ta = 25°C

Electrical Specifications

AEE01CC12-M Performance Curves

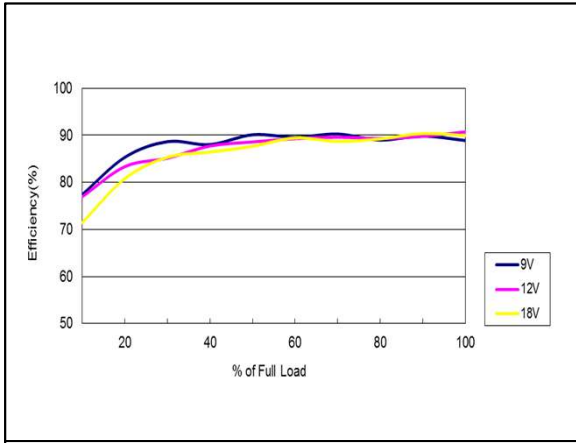

Figure 31: AEE01CC12-M Efficiency Versus Output Current Curve
 Vin = 9 to 18Vdc Load: Io = 0 to ±0.5A Ta = 25°C

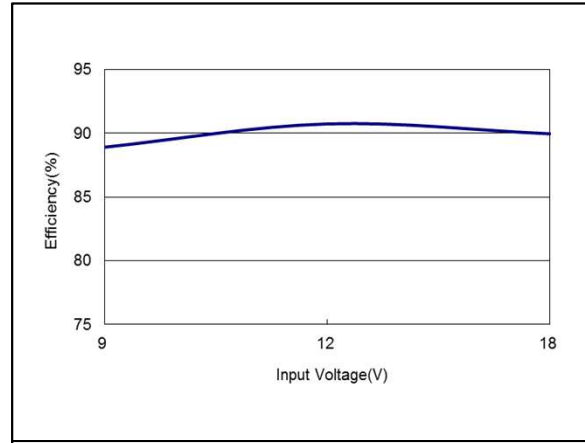

Figure 32: AEE01CC12-M Efficiency Versus Input Voltage Curve
 Vin = 9 to 18Vdc Load: Io = ±0.5A Ta = 25°C

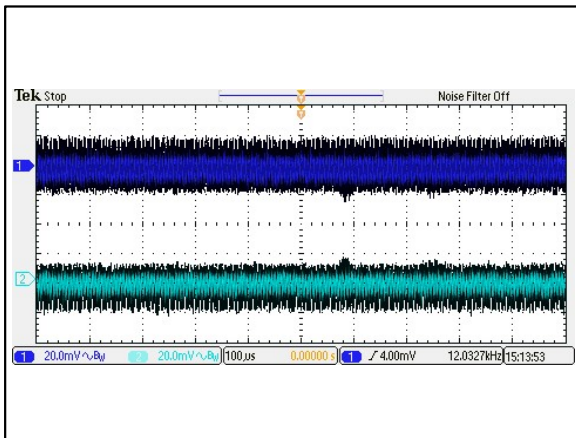

Figure 33: AEE01CC12-M Ripple and Noise Measurement
 Vin = 12Vdc Load: Io = ±0.5A Ta = 25°C
 Ch 1: Vo1 Ch 2: Vo2

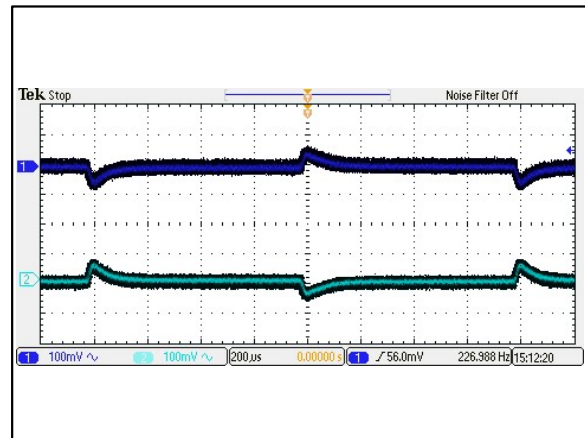

Figure 34: AEE01CC12-M Transient Response
 Vin = 12Vdc Load: Io = 100% to 75% load change Ta = 25°C
 Ch 1: Vo1 Ch 2: Vo2

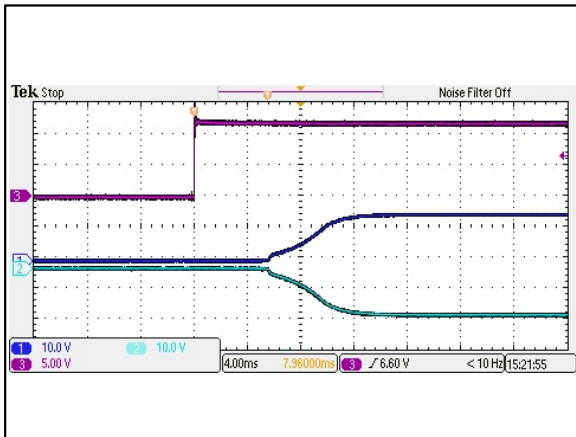

Figure 35: AEE01CC12-M Output Voltage Startup Characteristic by Vin
 Vin = 12Vdc Load: Io = ±0.5A Ta = 25°C
 Ch 1: Vo1 Ch 2: Vo2 Ch 3: Vin

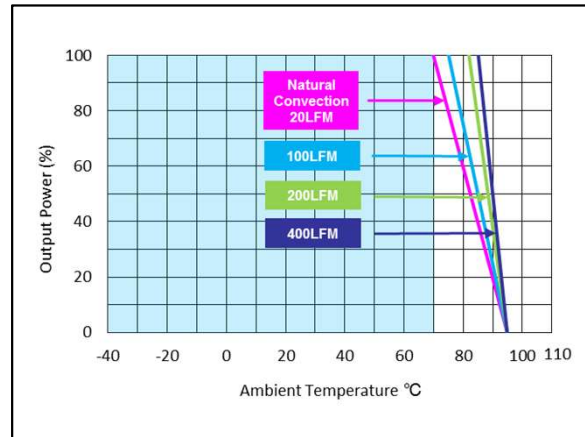

Figure 36: AEE01CC12-M Derating Curve (without heatsink).
 Vin = 12Vdc Load: Io = 0 to ±0.5A Ta = 25°C

Electrical Specifications

AEE03A24-M Performance Curves

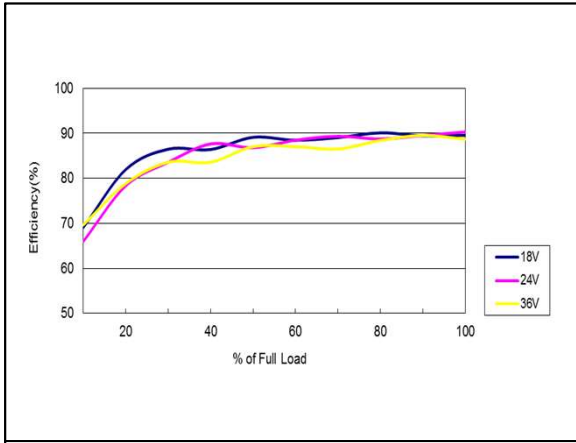

Figure 37: AEE03A24-M Efficiency Versus Output Current Curve
 Vin = 18 to 36Vdc Load: Io = 0 to 3A Ta = 25°C

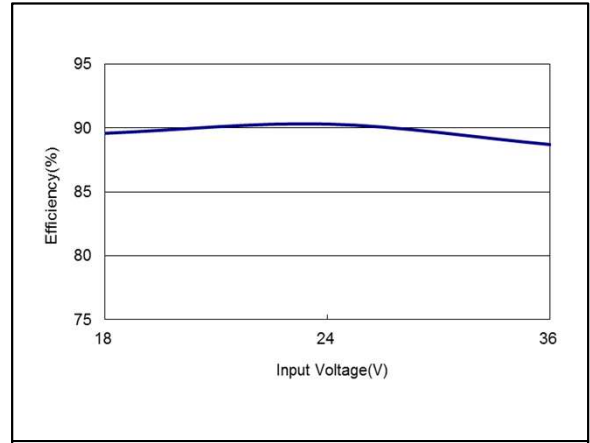

Figure 38: AEE03A24-M Efficiency Versus Input Voltage Curve
 Vin = 18 to 36Vdc Load: Io = 3A Ta = 25°C

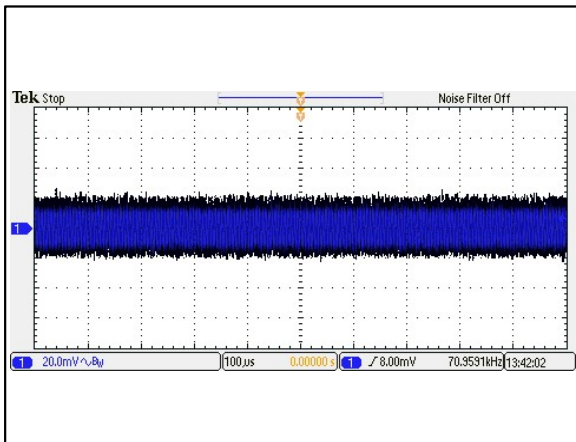

Figure 39: AEE03A24-M Ripple and Noise Measurement
 Vin = 24Vdc Load: Io = 3A Ta = 25°C
 Ch 1: Vo

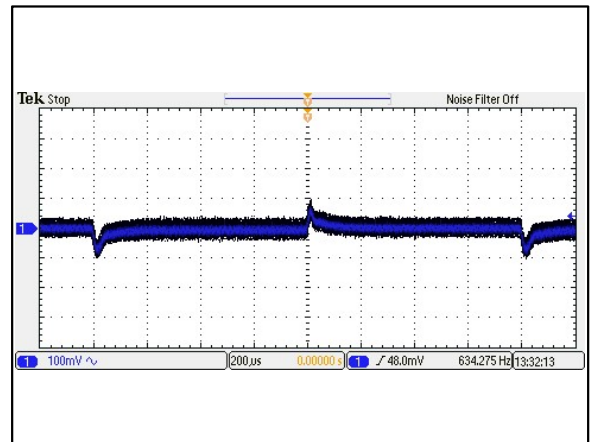

Figure 40: AEE03A24-M Transient Response
 Vin = 24Vdc Load: Io = 100% to 75% load change Ta = 25°C
 Ch 1: Vo

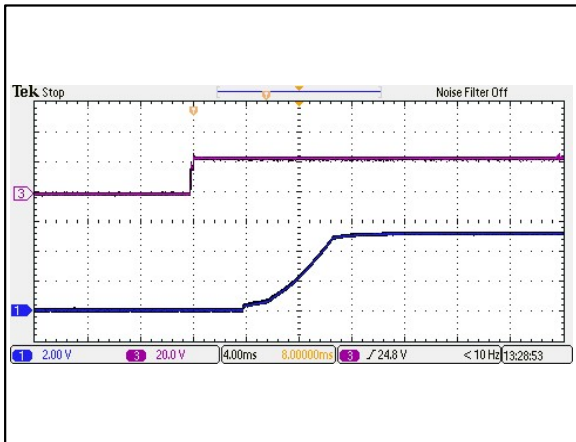

Figure 41: AEE03A24-M Output Voltage Startup Characteristic by Vin
 Vin = 24Vdc Load: Io = 3A Ta = 25°C
 Ch 1: Vo Ch 3: Vin

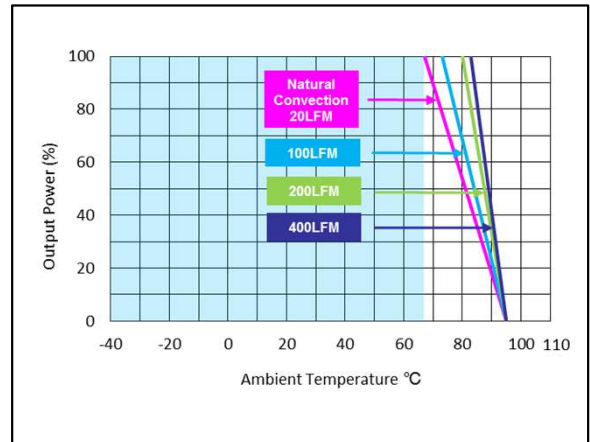

Figure 42: AEE03A24-M Derating Curve (without heatsink).
 Vin = 24Vdc Load: Io = 0 to 3A Ta = 25°C

Electrical Specifications

AEE01B24-M Performance Curves

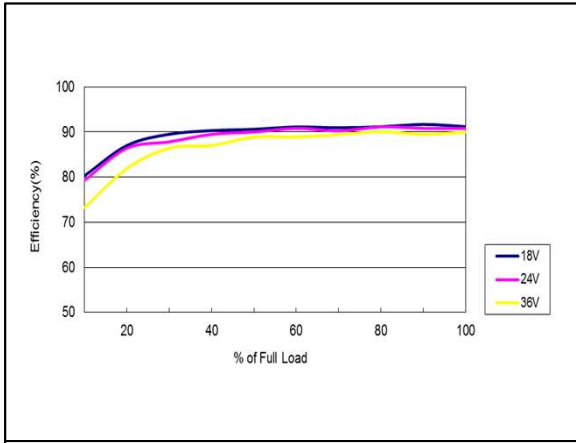

Figure 43: AEE01B24-M Efficiency Versus Output Current Curve
 Vin = 18 to 36Vdc Load: Io = 0 to 1.25A Ta = 25°C

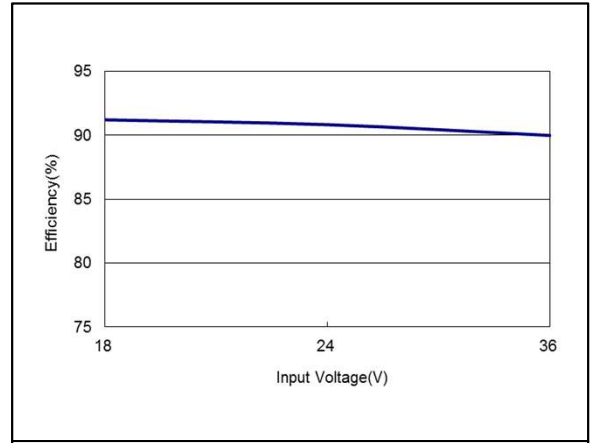

Figure 44: AEE01B24-M Efficiency Versus Input Voltage Curve
 Vin = 18 to 36Vdc Load: Io = 1.25A Ta = 25°C

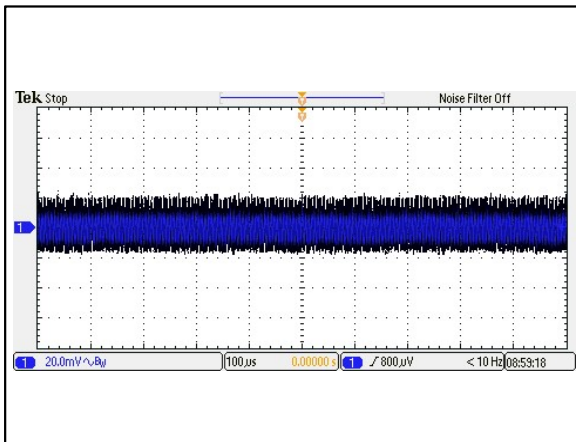

Figure 45: AEE01B24-M Ripple and Noise Measurement
 Vin = 24Vdc Load: Io = 1.25A Ta = 25°C
 Ch 1: Vo

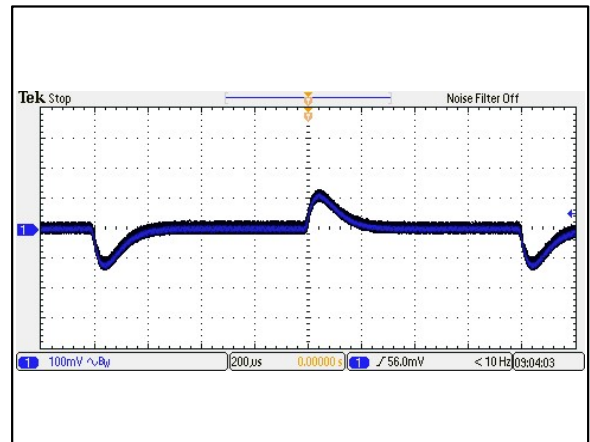

Figure 46: AEE01B24-M Transient Response
 Vin = 24Vdc Load: Io = 100% to 75% load change Ta = 25°C
 Ch 1: Vo

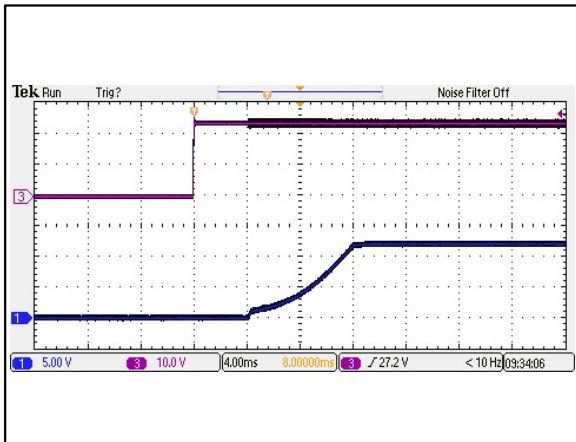

Figure 47: AEE01B24-M Output Voltage Startup Characteristic by Vin
 Vin = 24Vdc Load: Io = 1.25A Ta = 25°C
 Ch 1: Vo Ch 3: Vin

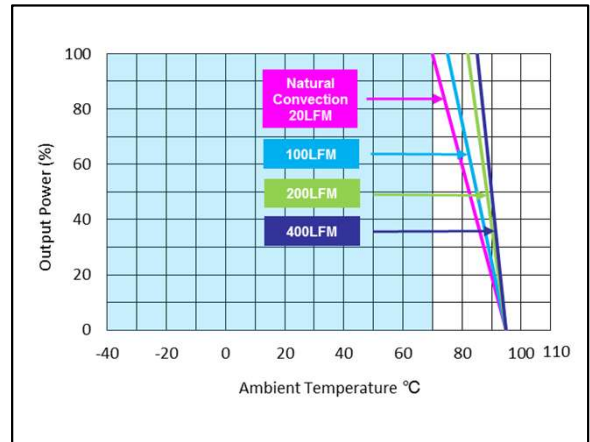

Figure 48: AEE01B24-M Derating Curve (without heatsink).
 Vin = 24Vdc Load: Io = 0 to 1.25A Ta = 25°C

Electrical Specifications

AEE01C24-M Performance Curves

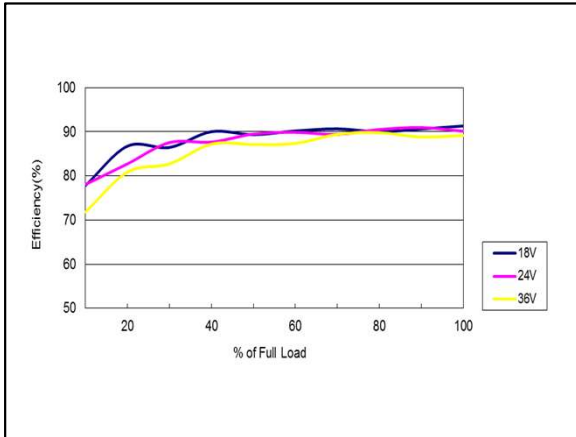

Figure 49: AEE01C24-M Efficiency Versus Output Current Curve
 Vin = 18 to 36Vdc Load: Io = 0 to 1A Ta = 25°C

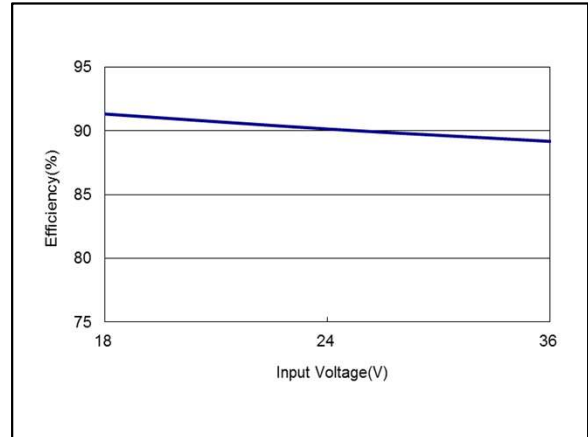

Figure 50: AEE01C24-M Efficiency Versus Input Voltage Curve
 Vin = 18 to 36Vdc Load: Io = 1A Ta = 25°C

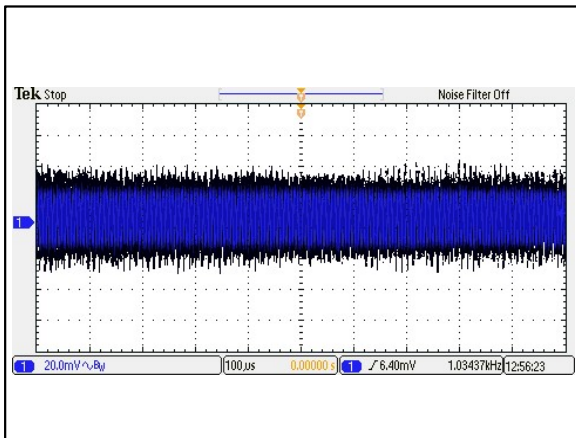

Figure 51: AEE01C24-M Ripple and Noise Measurement
 Vin = 24Vdc Load: Io = 1A Ta = 25°C
 Ch 1: Vo

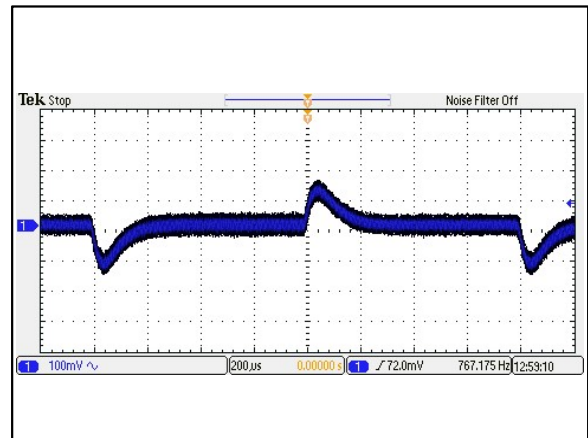

Figure 52: AEE01C24-M Transient Response
 Vin = 24Vdc Load: Io = 100% to 75% load change Ta = 25°C
 Ch 1: Vo

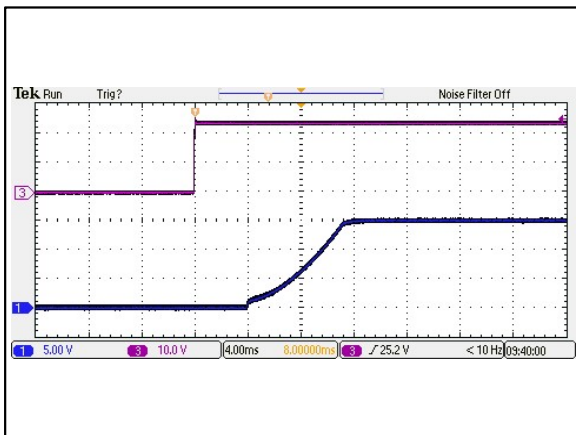

Figure 53: AEE01C24-M Output Voltage Startup Characteristic by Vin
 Vin = 24Vdc Load: Io = 1A Ta = 25°C
 Ch 1: Vo Ch 3: Vin

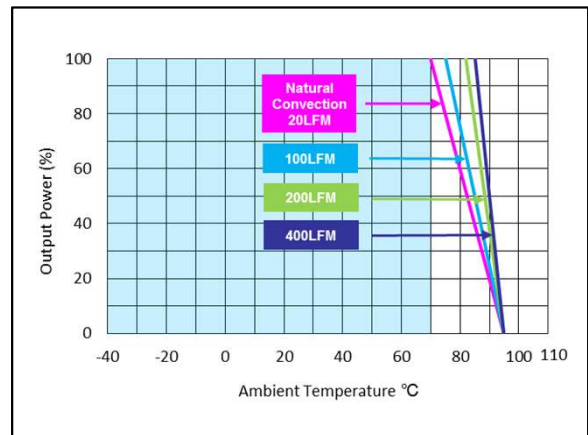

Figure 54: AEE01C24-M Derating Curve (without heatsink).
 Vin = 24Vdc Load: Io = 0 to 1A Ta = 25°C

Electrical Specifications

AEE01H24-M Performance Curves

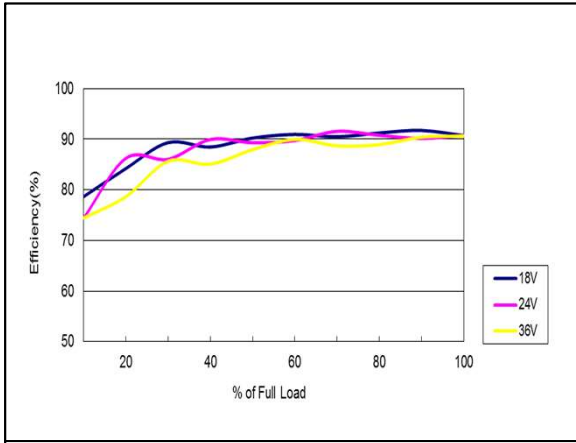

Figure 55: AEE01H24-M Efficiency Versus Output Current Curve
 Vin = 18 to 36Vdc Load: Io = 0 to 0.625A Ta = 25°C

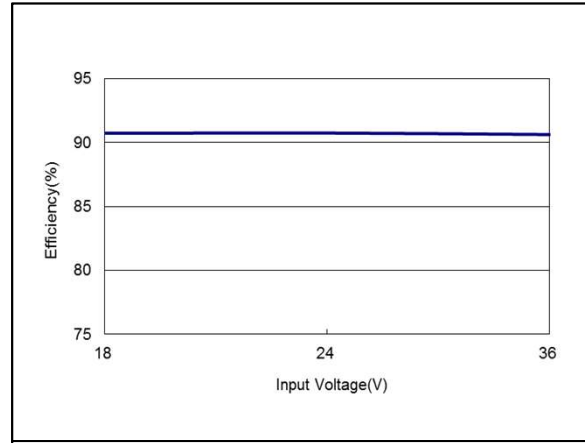

Figure 56: AEE01H24-M Efficiency Versus Input Voltage Curve
 Vin = 18 to 36Vdc Load: Io = 0.625A Ta = 25°C

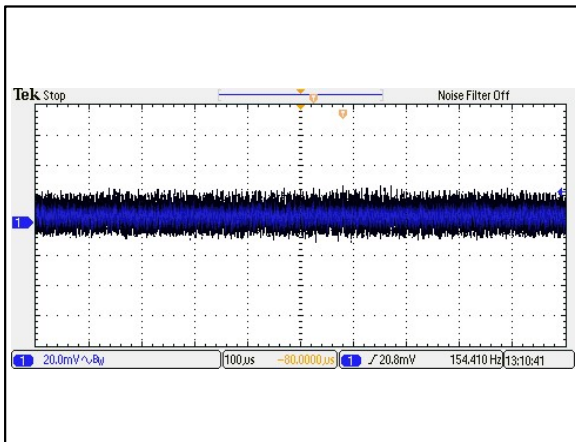

Figure 57: AEE01H24-M Ripple and Noise Measurement
 Vin = 24Vdc Load: Io = 0.625A Ta = 25°C
 Ch 1: Vo

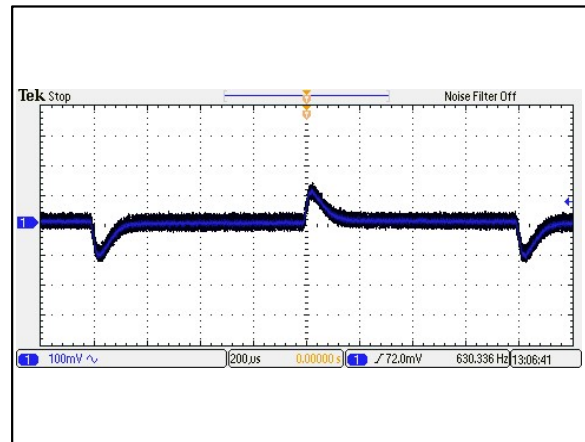

Figure 58: AEE01H24-M Transient Response
 Vin = 24Vdc Load: Io = 100% to 75% load change Ta = 25°C
 Ch 1: Vo

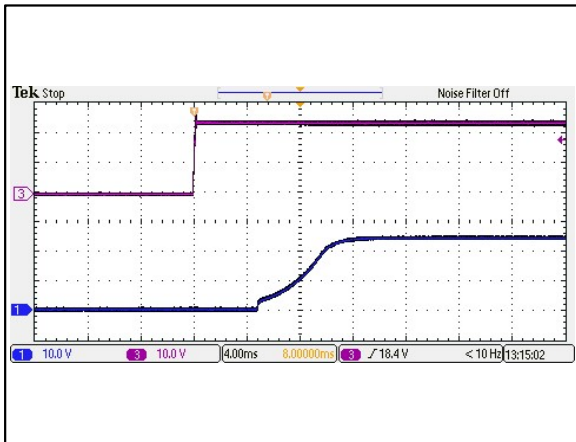

Figure 59: AEE01H24-M Output Voltage Startup Characteristic by Vin
 Vin = 24Vdc Load: Io = 0.625A Ta = 25°C
 Ch 1: Vo Ch 3: Vin

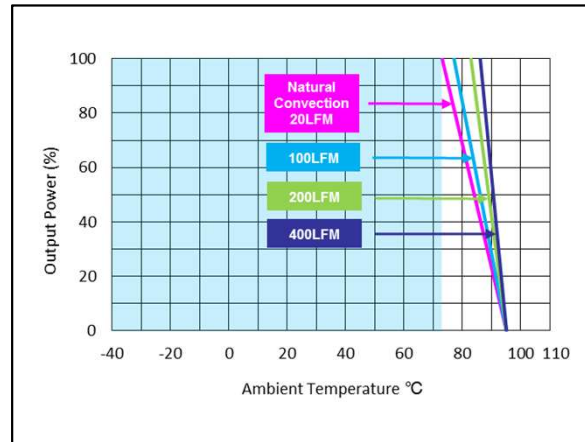

Figure 60: AEE01H24-M Derating Curve (without heatsink).
 Vin = 24Vdc Load: Io = 0 to 0.625A Ta = 25°C

Electrical Specifications

AEE01BB24-M Performance Curves

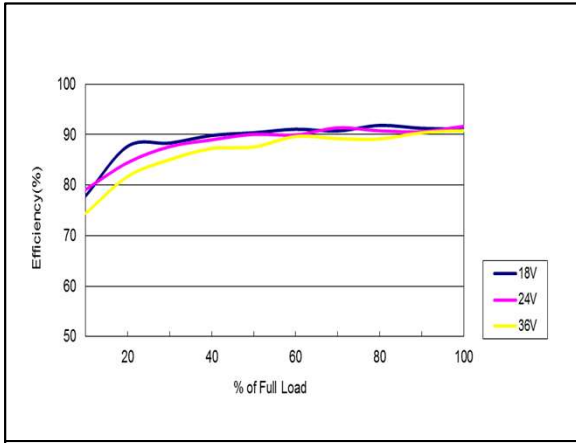

Figure 61: AEE01BB24-M Efficiency Versus Output Current Curve
 Vin = 18 to 36Vdc Load: Io = 0 to ±0.625A Ta = 25°C

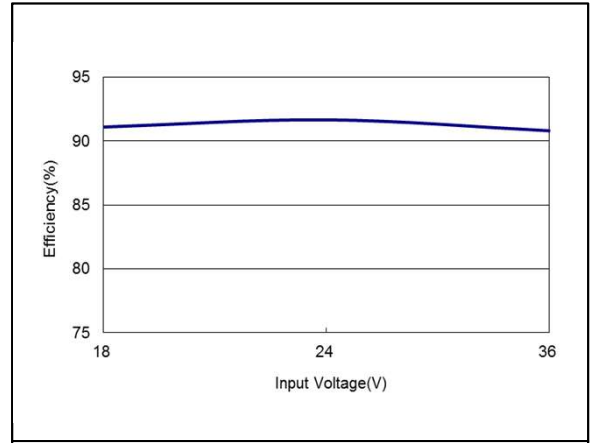

Figure 62: AEE01BB24-M Efficiency Versus Input Voltage Curve
 Vin = 18 to 36Vdc Load: Io = ±0.625A Ta = 25°C

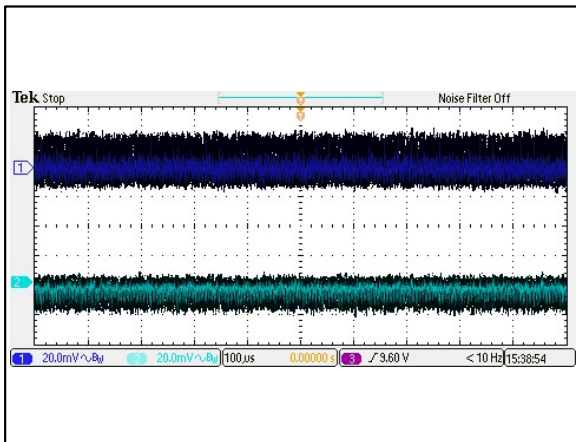

Figure 63: AEE01BB24-M Ripple and Noise Measurement
 Vin = 24Vdc Load: Io = ±0.625A Ta = 25°C
 Ch 1: Vo1 Ch 2: Vo2

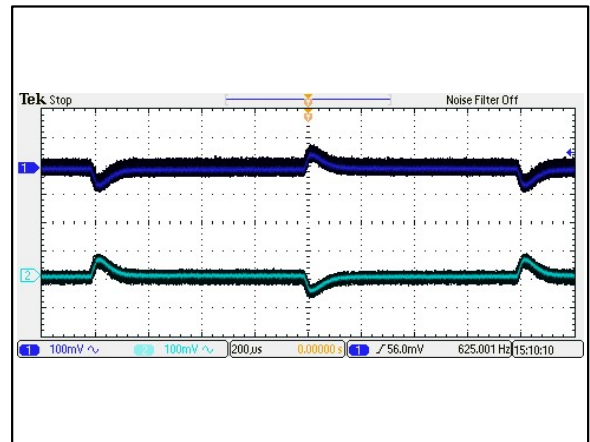

Figure 64: AEE01BB24-M Transient Response
 Vin = 24Vdc Load: Io = 100% to 75% load change Ta = 25°C
 Ch 1: Vo1 Ch 2: Vo2

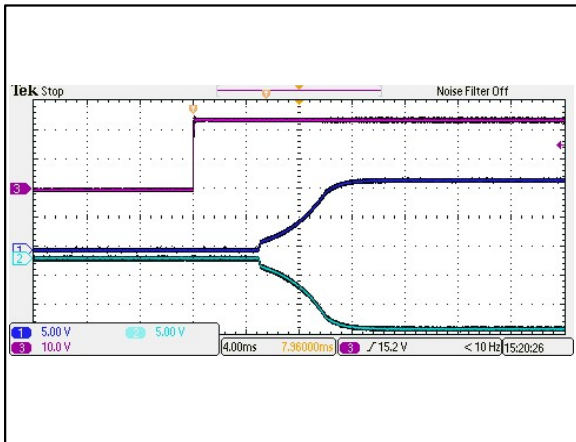

Figure 65: AEE01BB24-M Output Voltage Startup Characteristic by Vin
 Vin = 24Vdc Load: Io = ±0.625A Ta = 25°C
 Ch 1: Vo1 Ch 2: Vo2 Ch 3: Vin

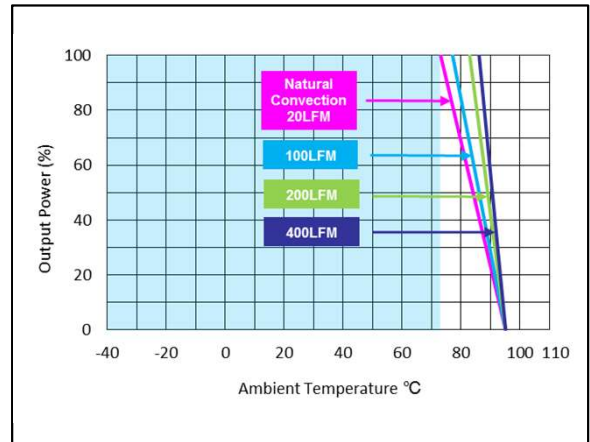

Figure 66: AEE01BB24-M Derating Curve (without heatsink).
 Vin = 24Vdc Load: Io = 0 to ±0.625A Ta = 25°C

Electrical Specifications

AEE01CC24-M Performance Curves

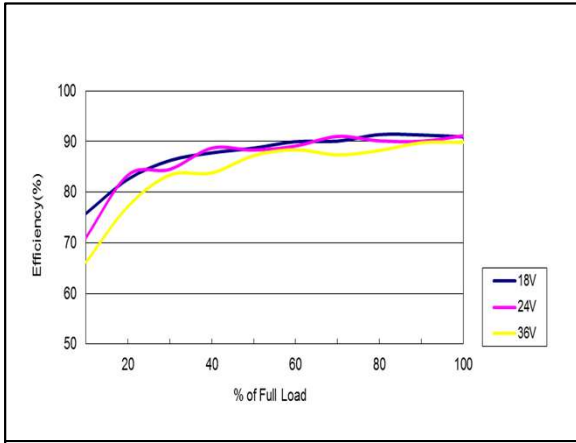

Figure 67: AEE01CC24-M Efficiency Versus Output Current Curve
 Vin = 18 to 36Vdc Load: Io = 0 to ±0.5A Ta = 25°C

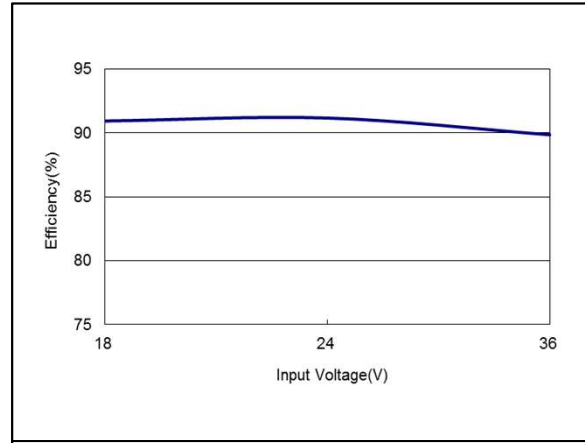

Figure 68: AEE01CC24-M Efficiency Versus Input Voltage Curve
 Vin = 18 to 36Vdc Load: Io = ±0.5A Ta = 25°C

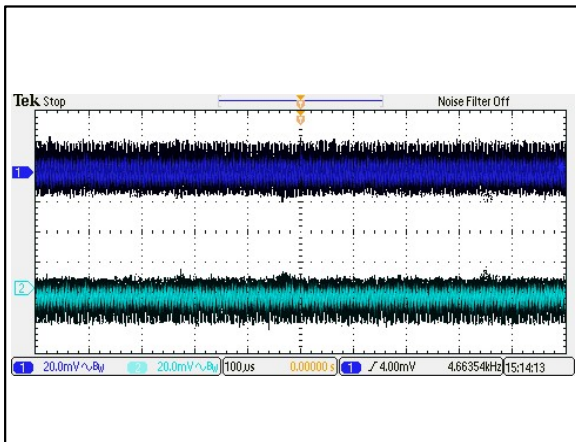

Figure 69: AEE01CC24-M Ripple and Noise Measurement
 Vin = 24Vdc Load: Io = ±0.5A Ta = 25°C
 Ch 1: Vo1 Ch 2: Vo2

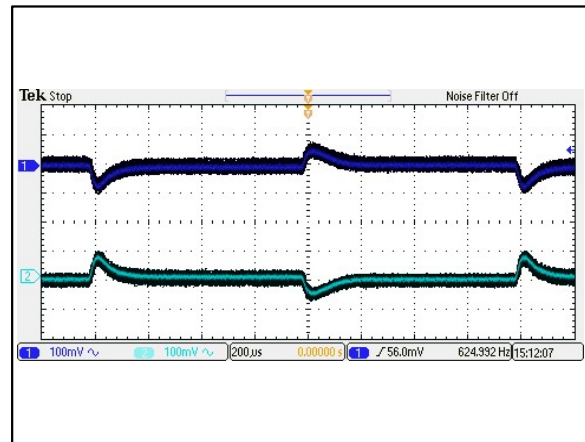

Figure 70: AEE01CC24-M Transient Response
 Vin = 24Vdc Load: Io = 100% to 75% load change Ta = 25°C
 Ch 1: Vo1 Ch 2: Vo2

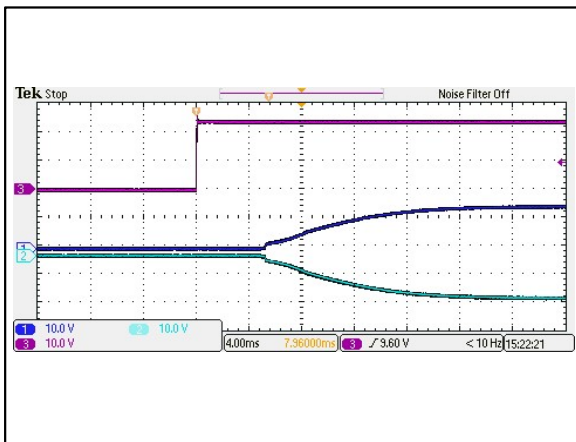

Figure 71: AEE01CC24-M Output Voltage Startup Characteristic by Vin
 Vin = 24Vdc Load: Io = ±0.5A Ta = 25°C
 Ch 1: Vo1 Ch 2: Vo2 Ch 3: Vin

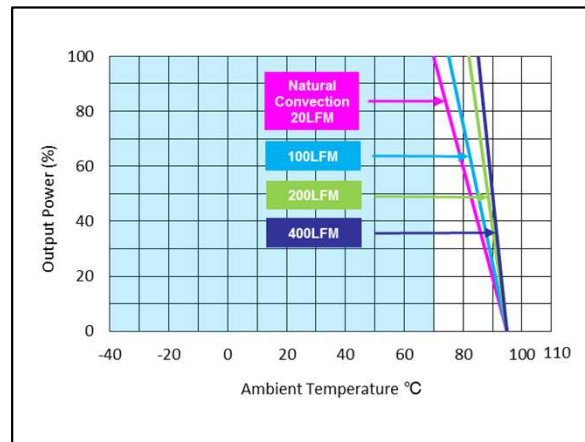

Figure 72: AEE01CC24-M Derating Curve (without heatsink).
 Vin = 24Vdc Load: Io = 0 to ±0.5A Ta = 25°C

Electrical Specifications

AEE03A48-M Performance Curves

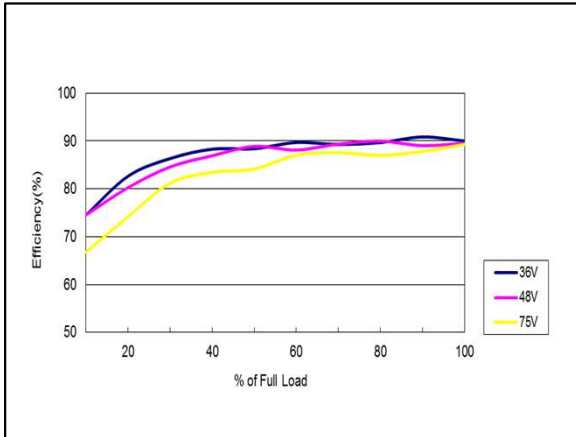

Figure 73: AEE03A48-M Efficiency Versus Output Current Curve
 Vin = 36 to 75Vdc Load: Io = 0 to 3A Ta = 25°C

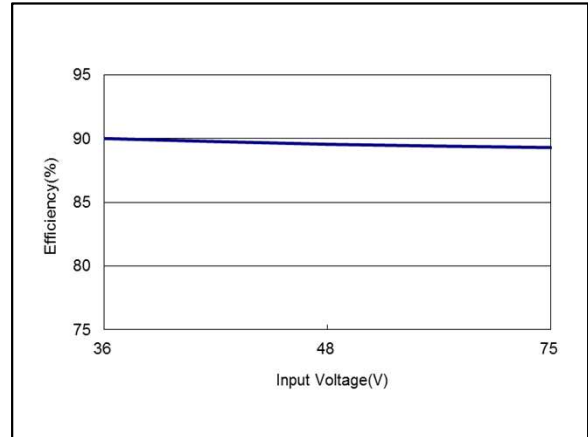

Figure 74: AEE03A48-M Efficiency Versus Input Voltage Curve
 Vin = 36 to 75Vdc Load: Io = 3A Ta = 25°C

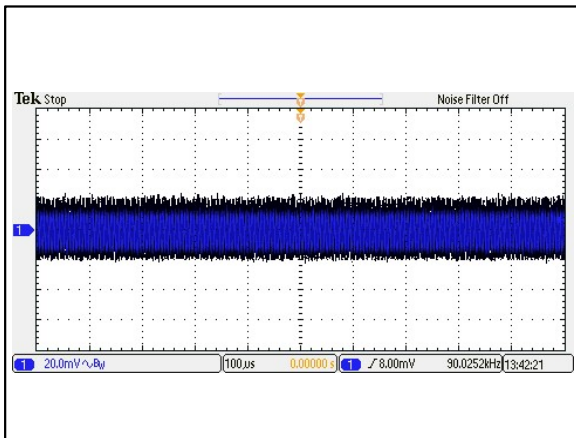

Figure 75: AEE03A48-M Ripple and Noise Measurement
 Vin = 48Vdc Load: Io = 3A Ta = 25°C
 Ch 1: Vo

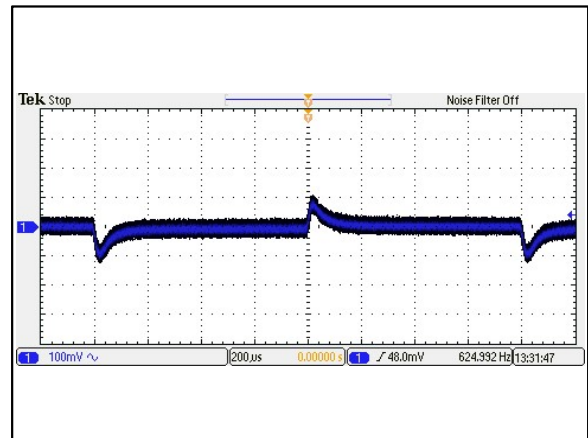

Figure 76: AEE03A48-M Transient Response
 Vin = 48Vdc Load: Io = 100% to 75% load change Ta = 25°C
 Ch 1: Vo

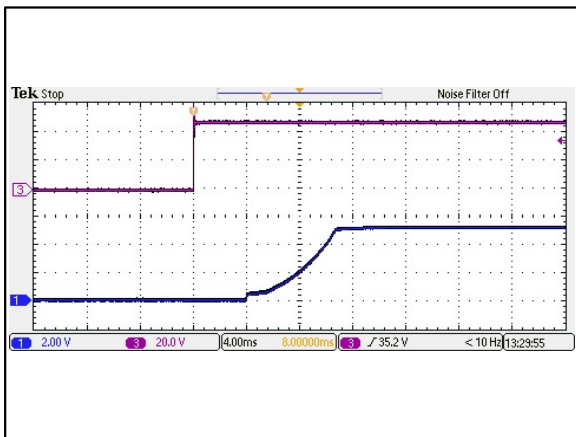

Figure 77: AEE03A48-M Output Voltage Startup Characteristic by Vin
 Vin = 48Vdc Load: Io = 3A Ta = 25°C
 Ch 1: Vo Ch 3: Vin

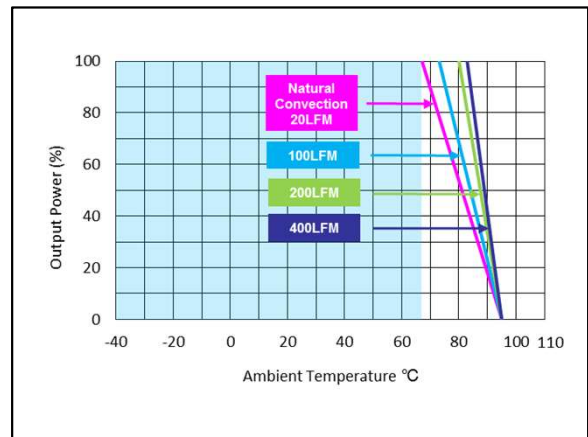

Figure 78: AEE03A48-M Derating Curve (without heatsink).
 Vin = 48Vdc Load: Io = 0 to 3A Ta = 25°C

Electrical Specifications

AEE01B48-M Performance Curves

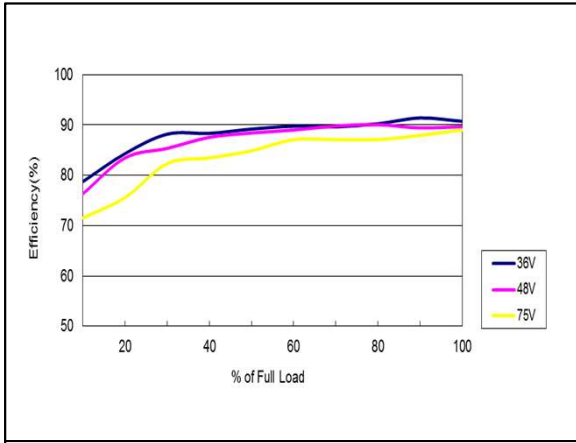

Figure 79: AEE01B48-M Efficiency Versus Output Current Curve
 Vin = 36 to 75Vdc Load: Io = 0 to 1.25A Ta = 25°C

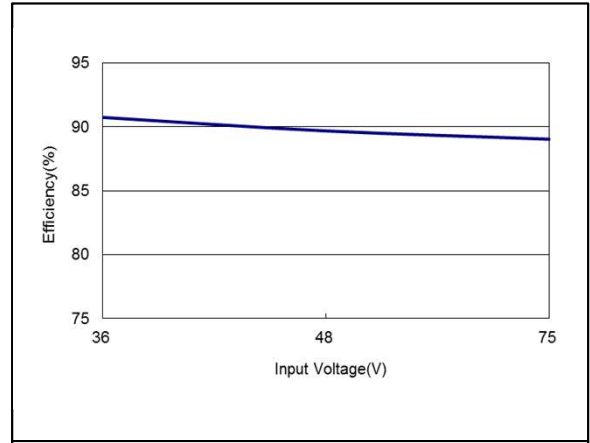

Figure 80: AEE01B48-M Efficiency Versus Input Voltage Curve
 Vin = 36 to 75Vdc Load: Io = 1.25A Ta = 25°C

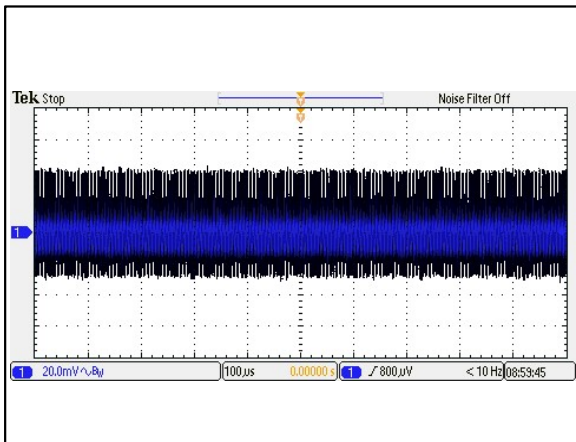

Figure 81: AEE01B48-M Ripple and Noise Measurement
 Vin = 48Vdc Load: Io = 1.25A Ta = 25°C
 Ch 1: Vo

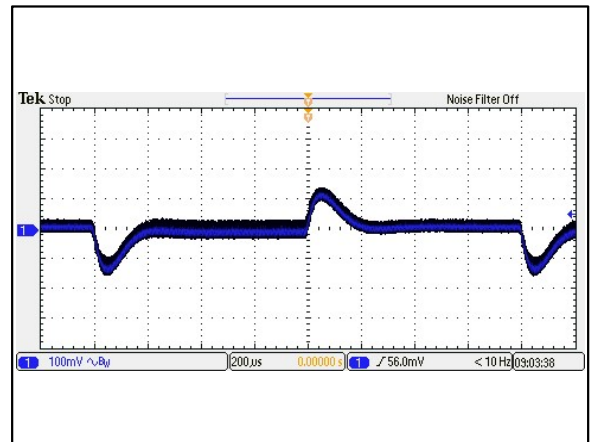

Figure 82: AEE01B48-M Transient Response
 Vin = 48Vdc Load: Io = 100% to 75% load change Ta = 25°C
 Ch 1: Vo

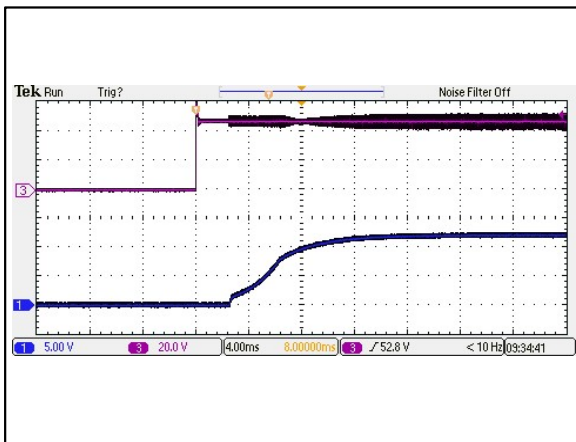

Figure 83: AEE01B48-M Output Voltage Startup Characteristic by Vin
 Vin = 48Vdc Load: Io = 1.25A Ta = 25°C
 Ch 1: Vo Ch 3: Vin

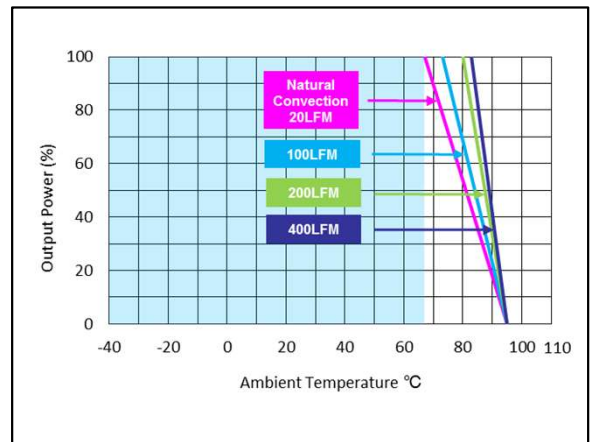

Figure 84: AEE01B48-M Derating Curve (without heatsink).
 Vin = 48Vdc Load: Io = 0 to 1.25A Ta = 25°C

Electrical Specifications

AEE01C48-M Performance Curves

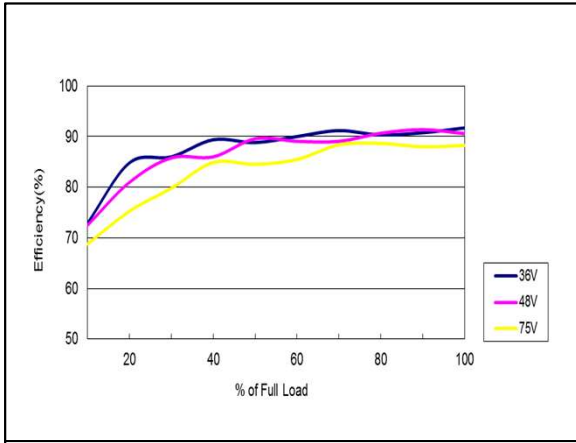

Figure 85: AEE01C48-M Efficiency Versus Output Current Curve
 Vin = 36 to 75Vdc Load: Io = 0 to 1A Ta = 25°C

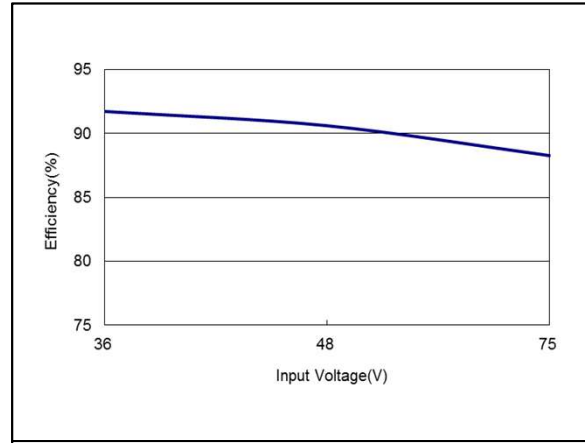

Figure 86: AEE01C48-M Efficiency Versus Input Voltage Curve
 Vin = 36 to 75Vdc Load: Io = 1A Ta = 25°C

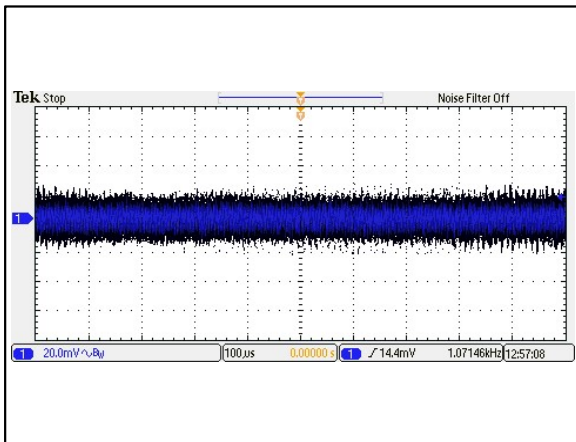

Figure 87: AEE01C48-M Ripple and Noise Measurement
 Vin = 48Vdc Load: Io = 1A Ta = 25°C
 Ch 1: Vo

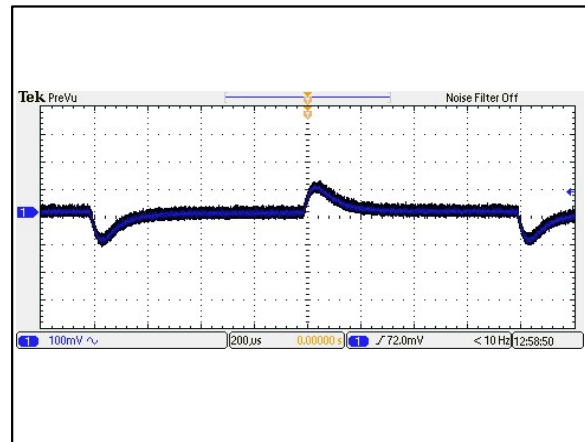

Figure 88: AEE01C48-M Transient Response
 Vin = 48Vdc Load: Io = 100% to 75% load change Ta = 25°C
 Ch 1: Vo

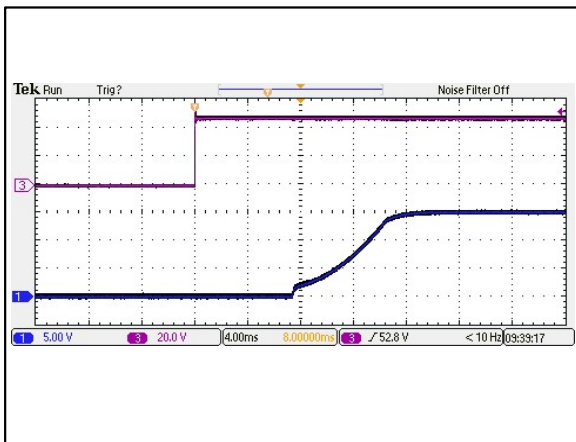

Figure 89: AEE01C48-M Output Voltage Startup Characteristic by Vin
 Vin = 48Vdc Load: Io = 1A Ta = 25°C
 Ch 1: Vo Ch 3: Vin

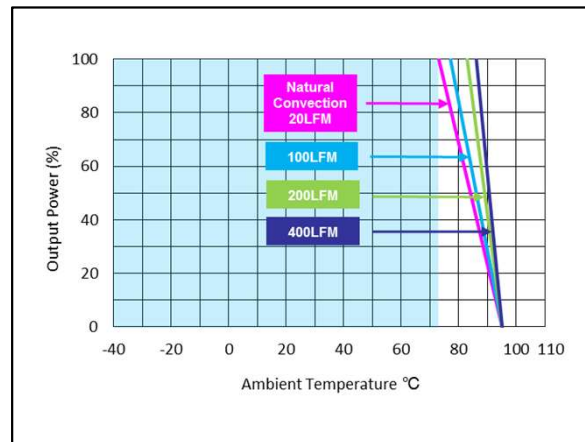

Figure 90: AEE01C48-M Derating Curve (without heatsink).
 Vin = 48Vdc Load: Io = 0 to 1A Ta = 25°C

Electrical Specifications

AEE01H48-M Performance Curves

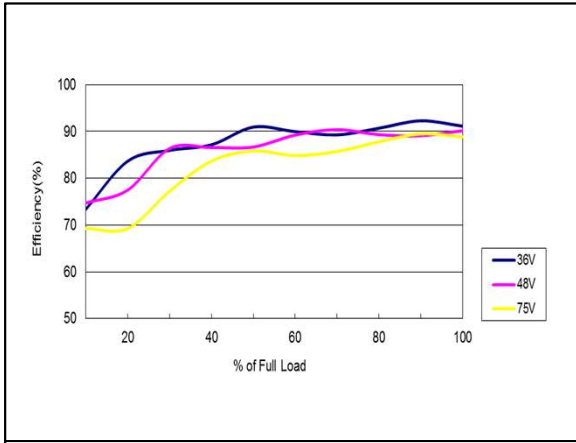

Figure 91: AEE01H48-M Efficiency Versus Output Current Curve
 Vin = 36 to 75Vdc Load: Io = 0 to 0.625A Ta = 25°C

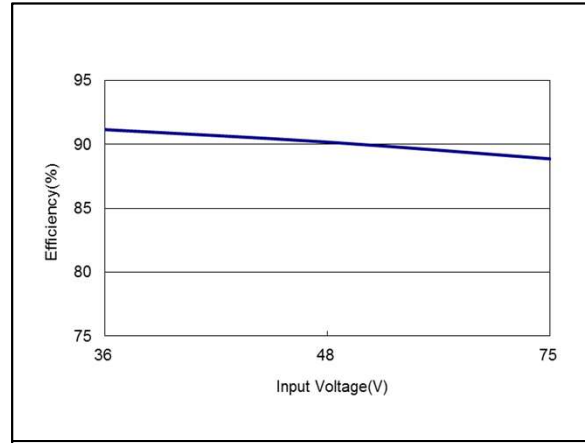

Figure 92: AEE01H48-M Efficiency Versus Input Voltage Curve
 Vin = 36 to 75Vdc Load: Io = 0.625A Ta = 25°C

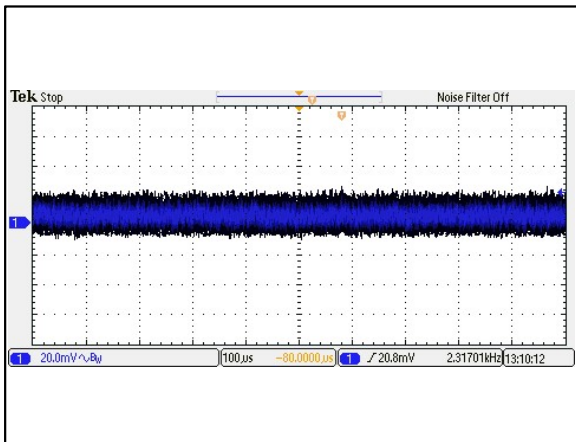

Figure 93: AEE01H48-M Ripple and Noise Measurement
 Vin = 48Vdc Load: Io = 0.625A Ta = 25°C
 Ch 1: Vo

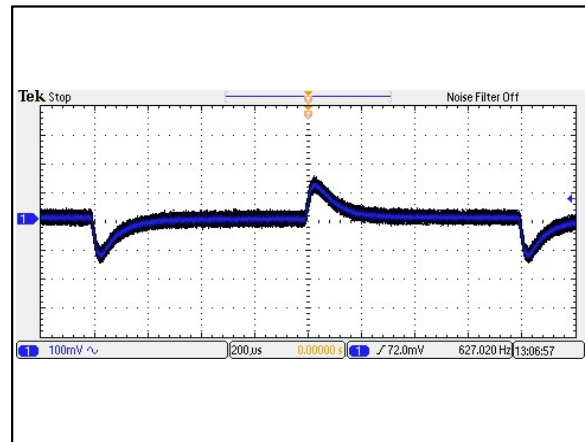

Figure 94: AEE01H48-M Transient Response
 Vin = 48Vdc Load: Io = 100% to 75% load change Ta = 25°C
 Ch 1: Vo

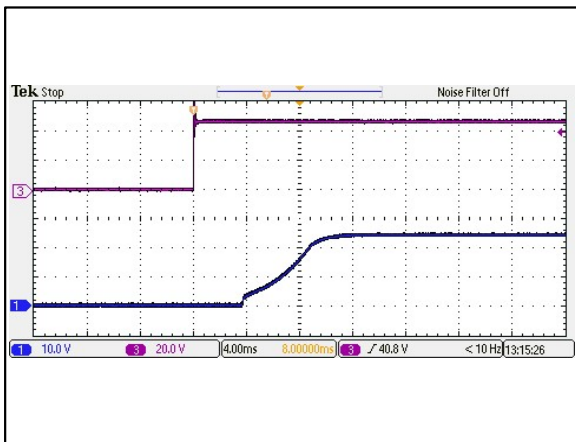

Figure 95: AEE01H48-M Output Voltage Startup Characteristic by Vin
 Vin = 48Vdc Load: Io = 0.625A Ta = 25°C
 Ch 1: Vo Ch 3: Vin

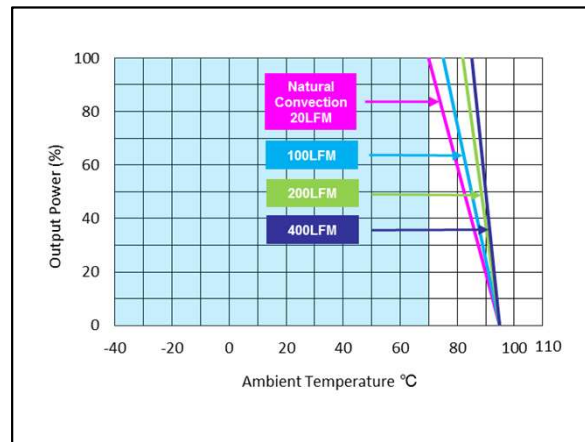

Figure 96: AEE01H48-M Derating Curve (without heatsink).
 Vin = 48Vdc Load: Io = 0 to 0.625A Ta = 25°C

Electrical Specifications

AEE01BB48-M Performance Curves

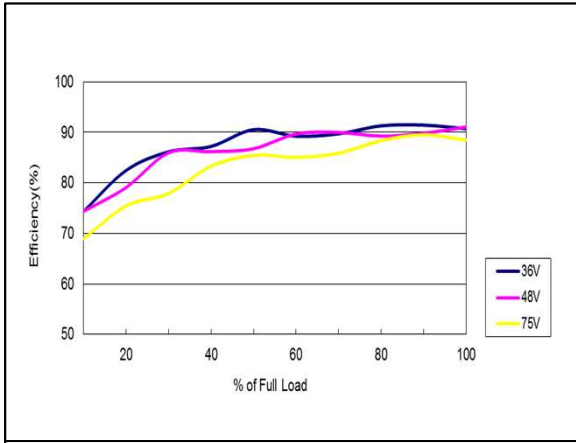

Figure 97: AEE01BB48-M Efficiency Versus Output Current Curve
 Vin = 36 to 75Vdc Load: Io = 0 to ±0.625A Ta = 25°C

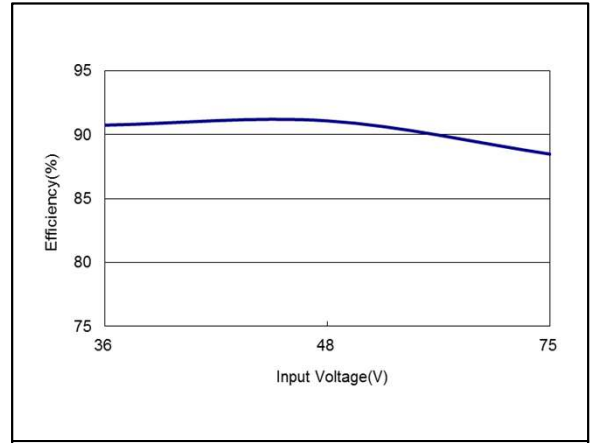

Figure 98: AEE01BB48-M Efficiency Versus Input Voltage Curve
 Vin = 36 to 75Vdc Load: Io = ±0.625A Ta = 25°C

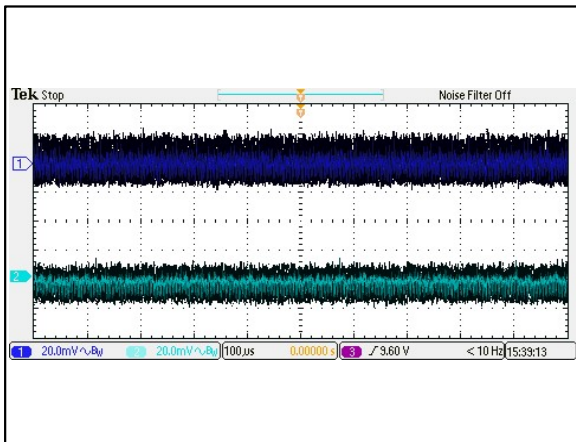

Figure 99: AEE01BB48-M Ripple and Noise Measurement
 Vin = 48Vdc Load: Io = ±0.625A Ta = 25°C
 Ch 1: Vo1 Ch 2: Vo2

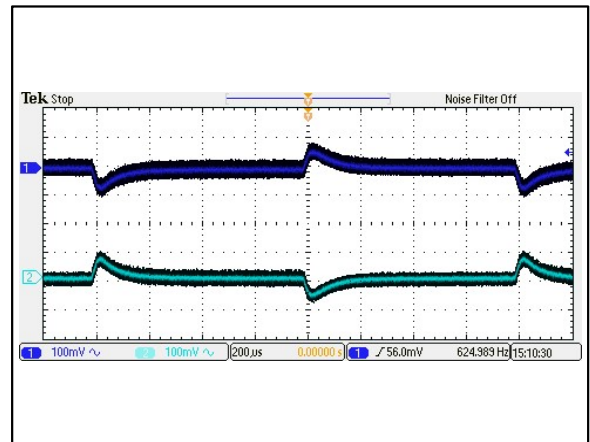

Figure 100: AEE01BB48-M Transient Response
 Vin = 48Vdc Load: Io = 100% to 75% load change Ta = 25°C
 Ch 1: Vo1 Ch 2: Vo2

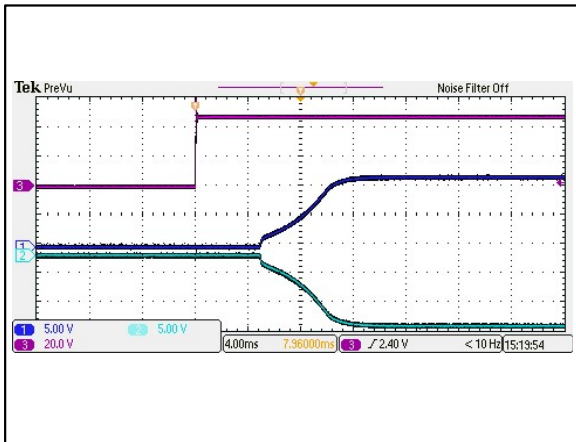

Figure 101: AEE01BB48-M Output Voltage Startup Characteristic by Vin
 Vin = 48Vdc Load: Io = ±0.625A Ta = 25°C
 Ch 1: Vo1 Ch 2: Vo2 Ch 3: Vin

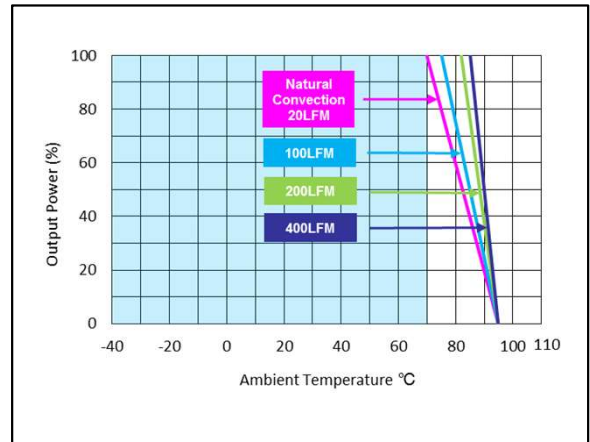

Figure 102: AEE01BB48-M Derating Curve (without heatsink).
 Vin = 48Vdc Load: Io = 0 to ±0.625A Ta = 25°C

Electrical Specifications

AEE01CC48-M Performance Curves

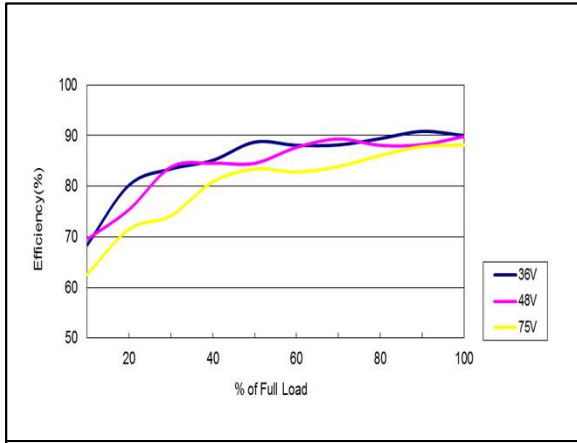

Figure 103: AEE01CC48-M Efficiency Versus Output Current Curve
 Vin = 36 to 75Vdc Load: Io = 0 to ±0.5A Ta = 25°C

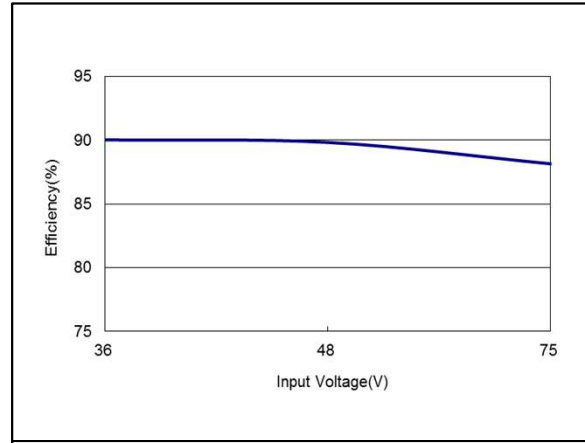

Figure 104: AEE01CC48-M Efficiency Versus Input Voltage Curve
 Vin = 36 to 75Vdc Load: Io = ±0.5A Ta = 25°C

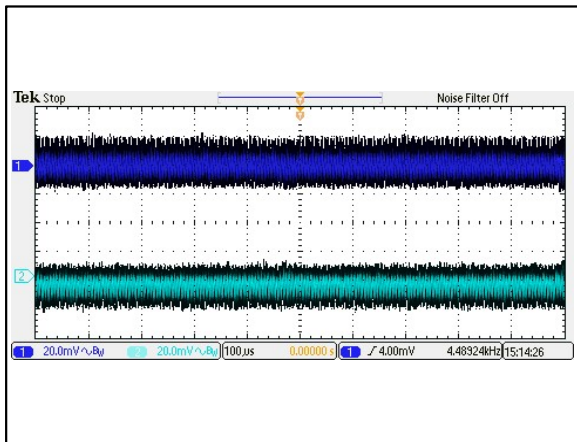

Figure 105: AEE01CC48-M Ripple and Noise Measurement
 Vin = 48Vdc Load: Io = ±0.5A Ta = 25°C
 Ch 1: Vo1 Ch 2: Vo2

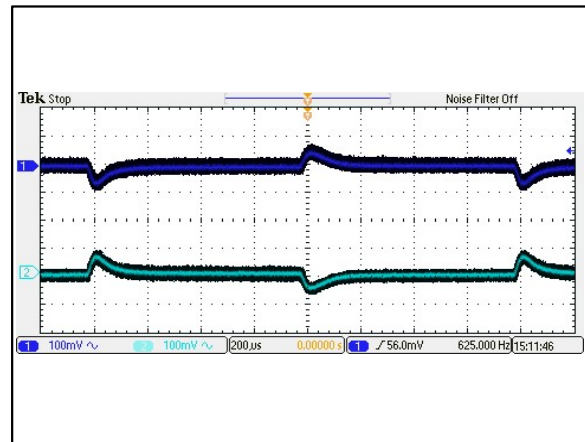

Figure 106: AEE01CC48-M Transient Response
 Vin = 48Vdc Load: Io = 100% to 75% load change Ta = 25°C
 Ch 1: Vo1 Ch 2: Vo2

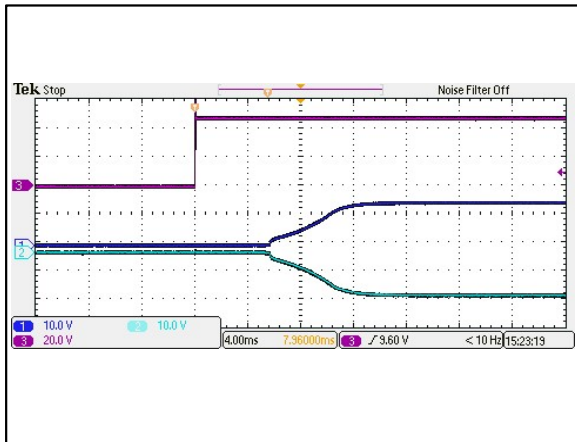

Figure 107: AEE01CC48-M Output Voltage Startup Characteristic by Vin
 Vin = 48Vdc Load: Io = ±0.5A Ta = 25°C
 Ch 1: Vo1 Ch 2: Vo2 Ch 3: Vin

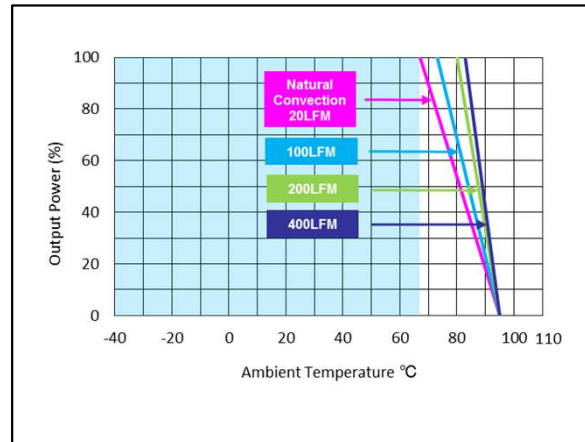
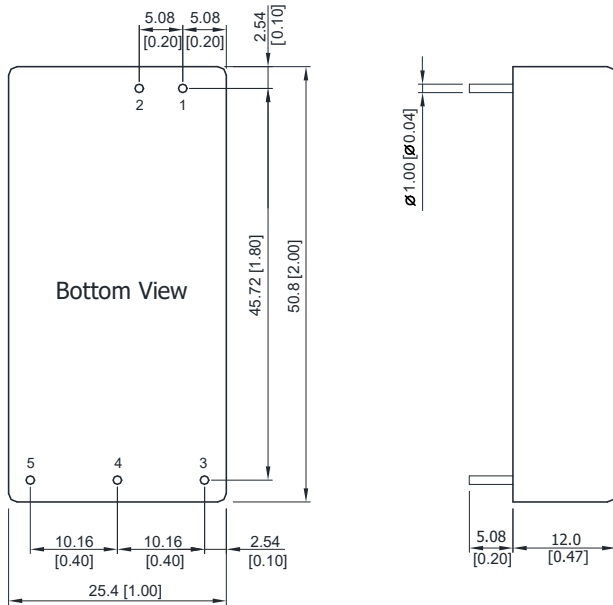

Figure 108: AEE01CC48-M Derating Curve (without heatsink).
 Vin = 48Vdc Load: Io = 0 to ±0.5A Ta = 25°C

Mechanical Specifications

Mechanical Outlines



Note:

- 1.All dimensions in mm (inches)
- 2.Tolerance: X.X±0.5 (X.XX±0.02)
X.XX±0.25 (X.XXX±0.01)
- 3.Pin diameter: 1.0±0.05 (0.04±0.002)

Pin Connections

Single output

- Pin 1 - +Vin
- Pin 2 - -Vin
- Pin 3 - +Vout
- Pin 4 - No Pin
- Pin 5 - -Vout

Dual Output

- Pin 1 - +Vin
- Pin 2 - -Vin
- Pin 3 - +Vout
- Pin 4 - Common
- Pin 5 - -Vout

Physical Characteristics

Case Size	50.8*25.4*12.00mm (2.0*1.0*0.47 inches)
Case Material	Non-Conductive Black Plastic (flammability to UL 94V-0 rated)
Pin Material	Tinned Copper
Weight	30g

Mechanical Specifications

Recommended Pad Layout

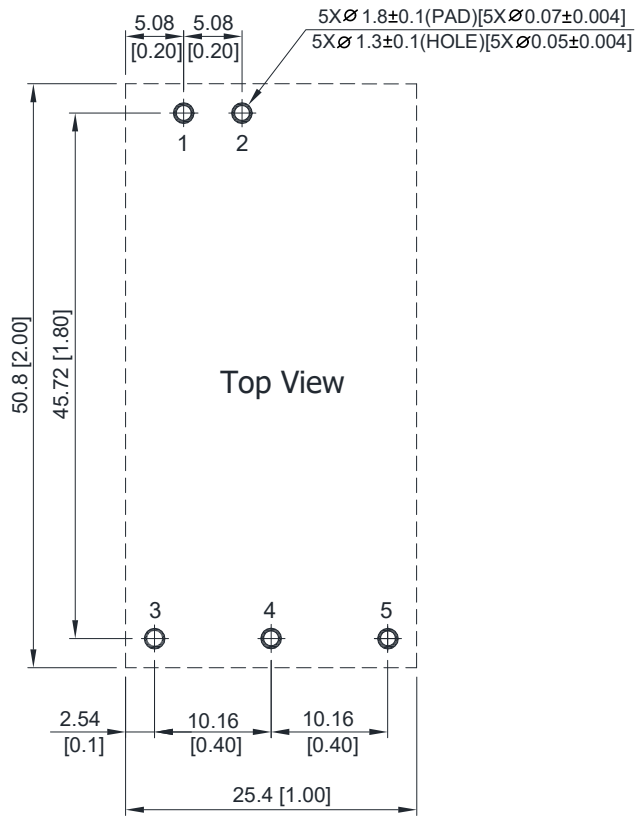

Environmental Specifications

EMC Immunity

AEE15W-M series power supply is designed to meet the following EMC immunity specifications.

Table 4. EMC Specifications			
Parameter	Standards & Level		Performance
EMI	Conduction & Radiation	EN55011, FCC part 15	Class A
EMS	EN60601-1-2, 4 th		
	ESD	EN61000-4-2 Air ± 15 kV, Contact ± 8 kV	Perf. Criteria A
	Radiated immunity	EN61000-4-3 10V/m	
	Fast transient ¹	EN61000-4-4 ± 2 KV	Perf. Criteria A
	Surge ¹	EN61000-4-5 ± 1 KV	Perf. Criteria A
	Conducted immunity	EN61000-4-6 10Vrms	Perf. Criteria A
	PFMF	EN61000-4-8 30A/M	Perf. Criteria A

Note 1: To meet EN61000-4-4 & EN61000-4-5, an external capacitor across the input pins is required.

Environmental Specifications

Safety Certifications

The AEE15W-M series power supply is intended for inclusion in other equipment and the installer must ensure that it is in compliance with all the requirements of the end application. This product is only for inclusion by professional installers within other equipment and must not be operated as a stand alone product.

Table 5. Safety Certifications for AEE15W-M series power supply system	
Document	Description
ANSI/AAMI ES60601-1, CAN/CSA-C22.2 No. 60601-1	International and Canada Medical Requirements
IEC/EN60601-1 3 rd Edition 2xMOPP	International and European Medical Requirements
ANSI/AAMI ES60601-1, 2xMOPP recognition (UL certificate), IEC/EN 60601-13 rd Edition (CB-report)	International and US Medical Requirements

Environmental Specifications

Operating Temperature

Table 6. Operating Temperature				
Parameter	Model / Condition	Min	Max	Unit
Operating Temperature Range (Natural Convection ¹ , See Derating)	AEE01H24-M AEE01BB24-M AEE01C48-M	-40	+73	°C
	AEE01B12-M AEE01CC12-M AEE01B24-M AEE01CC24-M AEE01H48-M AEE01BB48-M		+70	
	AEE01C12-M AEE01H12-M AEE01BB12-M AEE03A24-M AEE01C24-M AEE03A48-M AEE01B48-M AEE01CC48-M		+67	
	AEE03A12-M		+62	
Operating Case Temperature	All	-	+95	°C
Thermal Impedance (Natural Convection ¹)		13	-	°C/W
Storage Temperature Range		-50	+125	°C
Humidity (non-condensing)		-	95	%
Altitude		-	4000	m
Cooling	Natural Convection ¹			
Lead Temperature (1.5mm from case for 10Sec.)		-	260	°C

Note1 - The "natural convection" is about 20LFM but is not equal to still air (0 LFM).

Environmental Specifications

MTBF and Reliability

The MTBF of AEE15W-M series of DC/DC converters has been calculated using MIL-HDBK 217F NOTICE2, Operating Temperature 25 °C, Ground Benign.

Model	MTBF	Unit
AEE03A12-M	1,428,181	Hours
AEE01B12-M	1,927,407	
AEE01C12-M	2,026,516	
AEE01H12-M	1,780,163	
AEE01BB12-M	1,780,163	
AEE01CC12-M	2,108,738	
AEE03A24-M	1,646,820	
AEE01B24-M	1,975,949	
AEE01C24-M	2,068,481	
AEE01H24-M	2,019,674	
AEE01BB24-M	2,019,674	
AEE01CC24-M	2,134,001	
AEE03A48-M	1,749,638	
AEE01B48-M	1,866,230	
AEE01C48-M	1,953,706	
AEE01H48-M	1,809,937	
AEE01BB48-M	1,809,937	
AEE01CC48-M	2,031,988	

Application Notes

Input Reflected-Ripple Current Test Setup

Input reflected-ripple current is measured with an inductor L_{in} ($4.7\mu\text{H}$) and C_{in} ($220\mu\text{F}$, $\text{ESR} < 1.0\Omega$ at 100 KHz) to simulate source impedance. Capacitor C_{in} offsets possible battery impedance. Current ripple is measured at the input terminals of the module, measurement bandwidth is $0\text{-}500\text{ KHz}$.

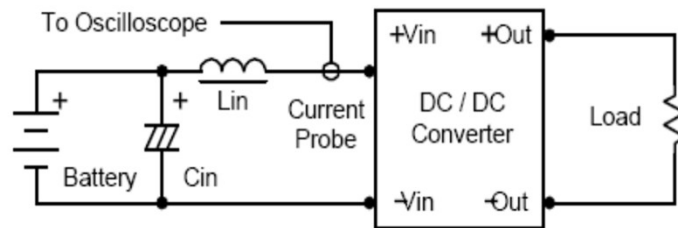

Component	Value	Reference
L_{in}	$4.7\mu\text{H}$	-
C_{in}	$220\mu\text{F}$ ($\text{ESR} < 1.0\Omega$ at 100KHz)	Aluminum Electrolytic Capacitor

Application Notes

Output Ripple Reduction

A good quality low ESR capacitor placed as close as practicable across the load will give the best ripple and noise performance. To reduce output ripple, it is recommended to use 4.7 μ F capacitors at the output.

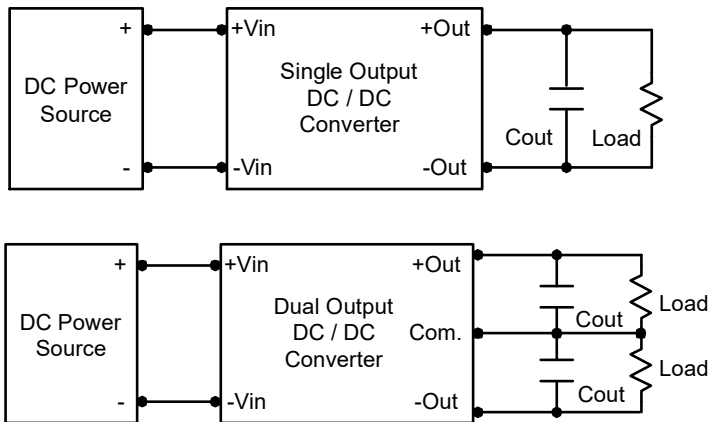

Peak-to-Peak Output Noise Measurement Test

Use a C_{out} 0.47 μ F ceramic capacitor. Scope measurement should be made by using a BNC socket, measurement bandwidth is 0-20MHz. Position the load between 50 mm and 75 mm from the DC/DC Converter.

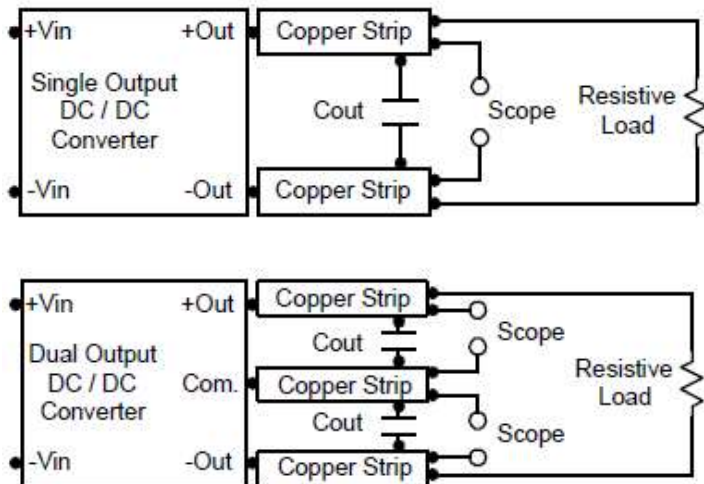

Application Notes

Input Source Impedance

The power module should be connected to a low ac-impedance input source. Highly inductive source impedances can affect the stability of the power module.

In applications where power is supplied over long lines and output loading is high, it may be necessary to use a capacitor at the input to ensure startup.

Capacitor mounted close to the power module helps ensure stability of the unit, it is recommended to use a good quality low Equivalent Series Resistance ($ESR < 1.0\Omega$ at 100KHz) capacitor of a 10uF for the 12V input modules and a 4.7uF for the 24V input modules and a 2.2uF for the 48V input modules.

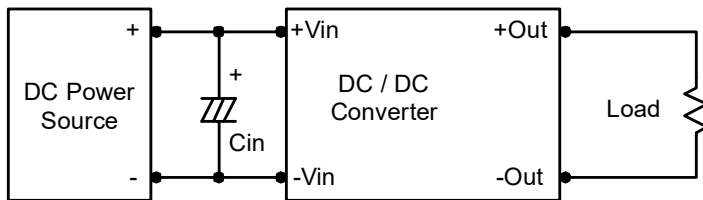

Output Over Current Protection

To provide hiccup mode protection in a fault (output overload) condition, the unit is equipped with internal current limiting circuitry and can endure overload for an unlimited duration.

Output Over Voltage Protection

The output overvoltage clamp consists of control circuitry, which is independent of the primary regulation loop, that monitors the voltage on the output terminals.

The control loop of the clamp has a higher voltage set point than the primary loop. This provides a redundant voltage control that reduces the risk of output overvoltage. The OVP level can be found in Table 3.

Thermal Considerations

Many conditions affect the thermal performance of the power module, such as orientation, airflow over the module and board spacing. To avoid exceeding the maximum temperature rating of the components inside the power module, the case temperature must be kept below 95°C. The derating curves are determined from measurements obtained in a test setup.

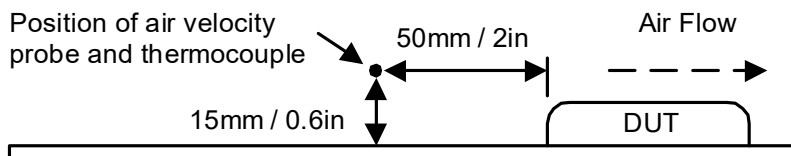

Maximum Capacitive Load

The AEE15W-M series has limitation of maximum connected capacitance at the output. The power module may be operated in current limiting mode during start-up, affecting the ramp-up and the startup time. The maximum capacitance can be found in the Table 3.

Application Notes

Packaging Information

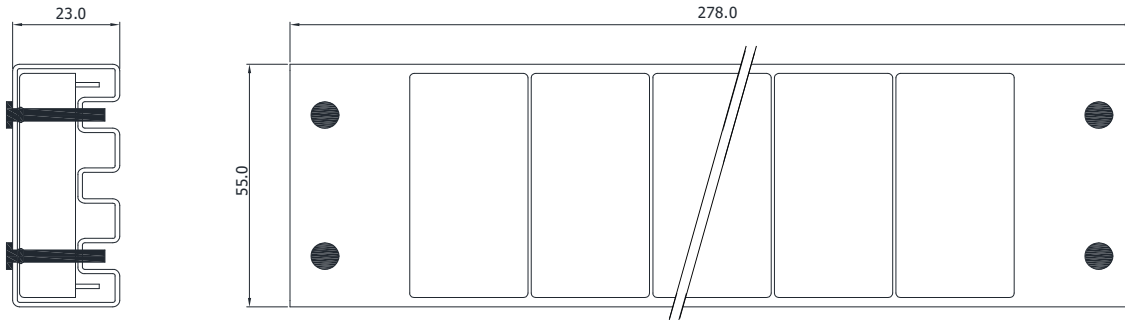

Soldering and Reflow Considerations

Lead free wave solder profile

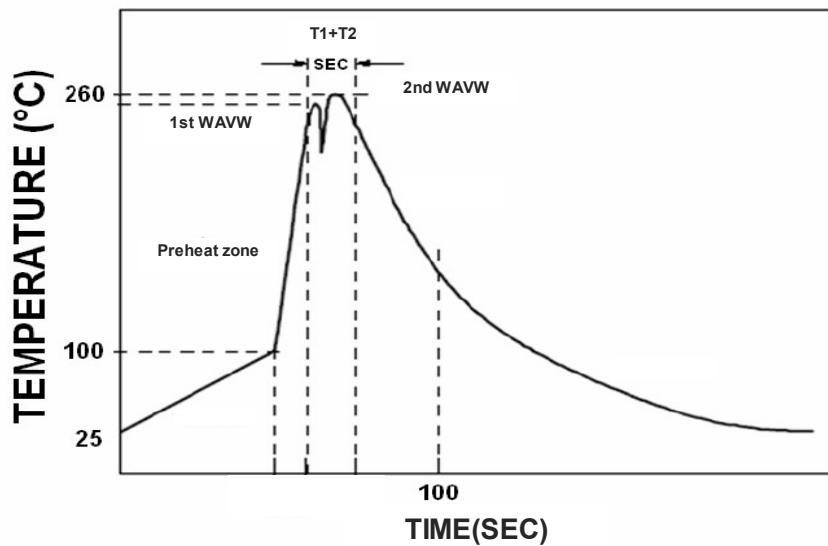

Profile Feature	Reference Parameter
Heating rate during preheat	Rise temp speed: 3°C/Sec max.
Final preheat temperature	Preheat temp : 100~130°C
Peak temperature	Peak temp: 250~260°C
Time within peak temperature	Peak time(T1+T2): 4~6 sec

Reference Solder: Sn-Ag-Cu: Sn-Cu: Sn-Ag
 Hand Welding: Soldering iron: Power 60W
 Welding Time: 2~4sec
 Temp.: 380~400°C

Record of Revision and Changes

Issue	Date	Description	Originators
1.0	01.11.2017	First Issue	XF.SUN
1.1	09.25.2017	Update the Efficiency, input current, derating curve, operating temperature, lead profile and safety standard.	XF.SUN



For international contact information,
visit advancedenergy.com.

powersales@aei.com (Sales Support)
productsupport.ep@aei.com (Technical Support)
+1 888 412 7832

ABOUT ADVANCED ENERGY

Advanced Energy (AE) has devoted more than three decades to perfecting power for its global customers. AE designs and manufactures highly engineered, precision power conversion, measurement and control solutions for mission-critical applications and processes.

Our products enable customer innovation in complex applications for a wide range of industries including semiconductor equipment, industrial, manufacturing, telecommunications, data center computing, and medical. With deep applications know-how and responsive service and support across the globe, we build collaborative partnerships to meet rapid technological developments, propel growth for our customers, and innovate the future of power.

PRECISION | POWER | PERFORMANCE

Specifications are subject to change without notice. Not responsible for errors or omissions. ©2020 Advanced Energy Industries, Inc. All rights reserved. Advanced Energy®, and AE® are U.S. trademarks of Advanced Energy Industries, Inc.