

SL POWER MB120 SERIES

120 Watts

Medical Power Supplies

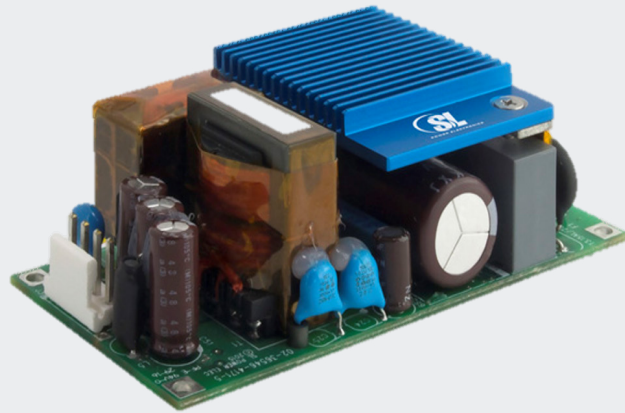

MB120 is a superior performance 120 Watt AC to DC power supply designed for next generation medical applications. Feature rich and highly efficient, the MB120 product family can easily fit in a 1U chassis and provides 100 Watts of convection cooled power. Input & output and internal temperature monitoring/alarms are features of the MB120 family. All models are CE marked to low voltage directive and approved to AAMI ES/CSA C22.2 No./EN/IEC60601-1 3rd edition. The design takes into consideration the pending international release of the new IEC 60601-1-2 4th edition EMC requirements. With low leakage current performance, the power supplies are BF compliant.

This application note will explain the features, benefits, and considerations while using MB120 in medical devices or systems with requirements to meet the medical standards.

FEATURES

Size

MB120 is a single output AC/DC power supply designed to fit into the 1U chassis. 1U is a rack unit or unit of measure defined as 1.752 inches (44.50mm). This unit of measure is most frequently used to define the overall height of 19-inch and 23-inch rack frames, as well as the height of equipment that mounts in these frames, whereby the height of the frame or equipment is expressed as multiples of rack units. While designing a system with a power supply the engineer must consider the heat dissipations from integrated components and ensure enough clearance between the parts. The small dimensions of MB120 2" x 4" x 1.25" (50.8mm x 101.6mm x 31.8mm) allow easily to integrate it into the 1U chassis with enough space for airflow or convection cooling from top and bottom surfaces.

Power vs. Temperature

The MB120 series power supplies are capable to provide up to 120 Watt power under 200 LFM air flow. However, at some applications cooling fans are not allowed due to higher IP ratings or where audible noise is a concern. In these systems the MB120 series still allows loads up to 100 Watts in a convection cooled environment up to 50°C. At higher temperatures, refer to the Power Derating curve to avoid the internal Over Temperature Protection (OTP) which shuts down the power supply during excessive temperature excursions. The Over Temperature Protection is based on a "Hiccup Mode" principle. Once the environment temperature is back to operational conditions the power supply output voltage auto-recovers. See the Proper Use and Thermal Considerations sections of this application note.

Premium Electrolytic Capacitors

Life time of the power supply is mostly dependent on life limiting components such as electrolytic capacitors. This is particularly the case for convection cooled applications. AC ripple currents in these capacitors create additional heat, but the main cause of temperature rise is from adjacent heat sources. The higher the long-term temperature of the electrolytic capacitors, the shorter the life of the capacitor. MB120 series were designed to keep the temperature of critical electrolytic capacitors as low as possible but also fitted with premium electrolytic capacitors to benefit from best technologies of capacitor manufacturers. This approach allows MB120 life cycle of over 10 years in standard business use condition at ambient temperature of 40°C.

Class B Conducted and Radiated EMI Performance Margins

SL Power electronics understands the difficulties to pass the EMC/EMI tests during the development of any product. The interference with electromagnetic emissions and increasing amount of product with wireless communications makes it difficult more than ever to remain within the dedicated EMI margins. MB120 series was designed to pass EN55032 Class B and FCC part 15 Class B with typical margin of 6db for conducted emissions and with typical margin of 3db for radiated emissions. The final enclosure of the system might add additional radiation shielding and is dependent on the type of system.

Safety and Isolation Type Rated

MB120 series provides 2 x Means of Patient Protection (MOPP) to avoid electrical shock to a patient with weak immune system. All models are CE marked to low voltage directive and approved to AAMI ES/CSA C22.2 No./EN/60601-1 3rd Edition. Please contact the application engineering team for CE/UL certificates or CB reports if not found on the www.slpower.com website for this product.

FEATURES

BF type isolation is referenced in safety standard IEC60601-1 to define patient applied part classification. BF means Body Floating which must provide higher degree of protection against electric shock than that provided by type B applied parts. Systems with type BF applied parts allow patient's body to be at an elevated electrical potential and complying with the specified requirements of standard IEC60601-1. The symbol of BF type is regulated by standard IEC 60417-5333 and looks like this.



Designed to Meet New IEC 60601-1-2 4th Edition EMC Requirements

The new 4th edition of standard IEC60601-1-2 for EMC requirements was lately released. Most significant change of the standard is harmonization with IEC60601-1-11 to classify medical devices into two main groups, professional healthcare facility environment and home healthcare environment which is more stringent and desires more attention of system designers. The key differences are listed in the application note AN-G010.

It is important to note that IEC 60601-1-2 4th Edition, is the EMC standard and not to be confused with safety standard IEC 60601-1 3rd edition. While a system must be approved to IEC 60601-1-2 standard a power supply is just part of it therefore certification is given at the system level. However, as some of the tests are directly related to functionality of the power supply the design takes into consideration the the new IEC 60601-1-2 4th Edition EMC requirements.

Leakage Current

Because of the lower values of allowable leakage current in medical power supplies, it is important to substantially reduce the capacitances that cause leakage currents. Reducing their value can severely reduce the EMI filter's effectiveness. SL Power medical designs EMI filtering techniques have overcome these problems. Patient Leakage Current (Output to Earth) of MB120 is <math> < 90 \mu A @ 264VAC </math> 60Hz input, NC which is also suitable for BF type applications

PROPER USE

The MB120 power supplies have high power conversion efficiency however they do rely on convection cooling in the surrounding environment (air) to prevent overheating or excessive component temperatures. Therefore, there needs to be adequate access to ambient air to ensure proper thermal performance of the power supply.

Do not exceed the power rating of the product.

The supply should be mounted to an electrically conductive surface with conductive standoffs for proper EMI/EMC performance. Be aware, standoffs are electrically connected to functional ground.

Mounting standoff height should be $\geq 5\text{mm}$, for more information please refer to application note "open frame".

A non-conductive insulator should be placed between the bottom of the unit and any conductive surface to ensure minimal creepage clearance according to the safety standard. If Insulator is not possible increase standoffs to 8mm to the bottom components or leads to keep safety clearance.

The heat sink of MB120 is electrically connected to primary side high voltage return (bulk cap return) and is not isolated from the AC mains. For conductive cooling method an electrically isolating thermal pad with sufficient insulation should be placed between the heat sink and any conductive surface to meet safety requirements.

PROPER USE

The MB120 is designed for Class I AC input applications. The MB120 and the chassis must be bonded to protective earth in the end product. Using the MB120 earth terminal for the end product protective earthing is not recommended and a separate dedicated bonding conductor and suitable termination should be used to connect the chassis to the end product protective earth.

Use a proper mating connector for connection to the input, output and signal connectors of the power supply. Refer to the MB120 datasheet for connector information.

For better EMI performance avoid cable routing close to power supply especially near magnetics or switching components. If that is not possible, consider shielding cables or power supply. Contact local SLPE application engineer for support.

If the system requires additional EMI filter, carefully consider properly selecting system EMI filters. That can make EMI worse if not properly selected

THERMAL CONSIDERATIONS

Following table lists components of MB120 series and their maximal allowed temperature. Monitoring and keeping these parts below the limits helps to keep complete power supply within the given limits. Take proper precautions when measuring component temperatures as some components are located on the hazardous voltage (mains) side of the power supply. Thermal couples need to be electrically isolated

Description	Hazardous Voltage	Reference Designator	Max. Allowed Temperature
Capacitor X-Type	Yes	C5	100°C
Input Bulk Capacitor	Yes	C2	105°C
Output Capacitors	-	C51, C52, C54	105°C
Electrolytic Capacitor	-	C99	105°C
Power Transformer	Yes	T1	145°C
Inductors	Yes	L1, L3	130°C

·As already mentioned, life of electrolytic capacitors is significantly affected by temperature. It is strongly recommended to keep their temperature 5°C to 10°C below the max allowed values in the table under worst case condition especially without active air flow.

·Even if power transformer and inductors offer enough thermal margin from maximal allowed temperature their temperature can reach 110°C and must be considered carefully while placing other system components near it.

·For best worst-case verification, use low line input voltage 90VAC with highest load at 50°C. Place thermocouples to listed components on a non-conductive area to measure excessive temperatures and to determine correct thermal design.

·Caution! Almost all components are located on primary side of AC-DC power supply! Use appropriate safety measures as these components are at hazardous voltage levels. Only qualified personnel should attempt to make these measurements.

THERMAL CONSIDERATIONS

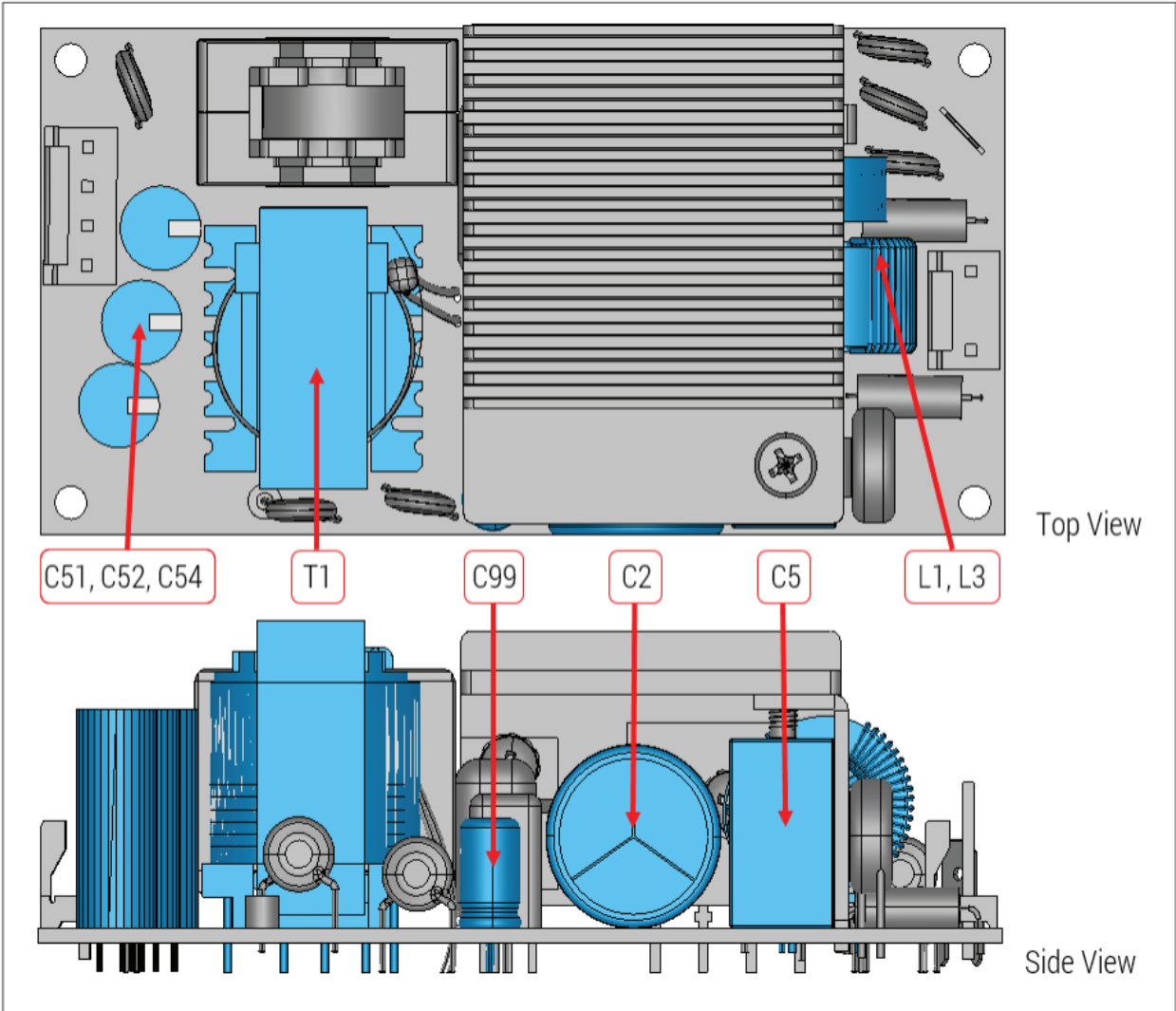

PERFORMANCE DATA

Most of the data presented in the following section are for the 12V and 24V MB120 models. Data for other voltages are available upon request.

Inrush Current

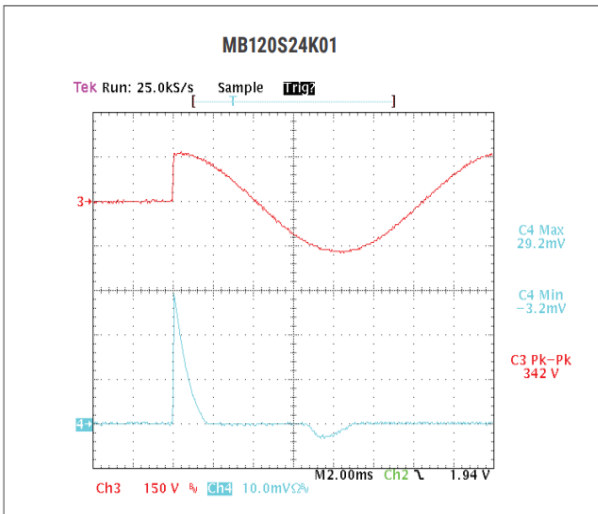

Fig. 02: INRUSH CURRENT AT 115VAC 24V/5A – CH4: 10A/Div.
I(inrush) = 29.2A peak.
 $I^2t = 0.34A^2s$.

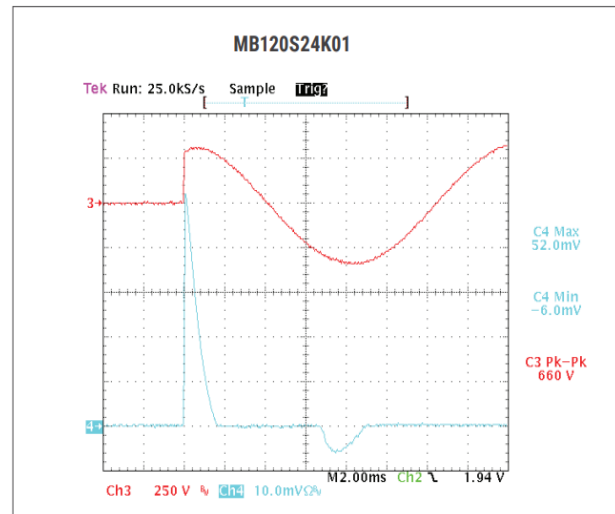

Fig. 03: INRUSH CURRENT AT 230VAC 24V/5A – CH3: 10A/Div.
I(inrush) = 52A peak.
 $I^2t = 1.08A^2s$.

Output Turn-On Delay Time

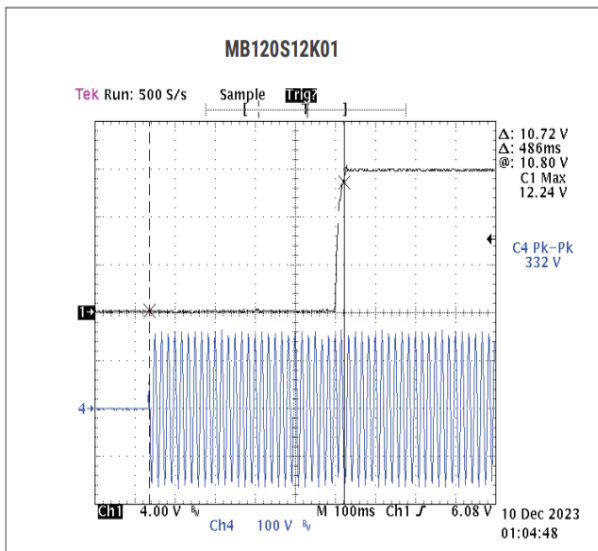

Fig. 04: TURN-ON DELAY AT 115VAC – 10A LOAD.

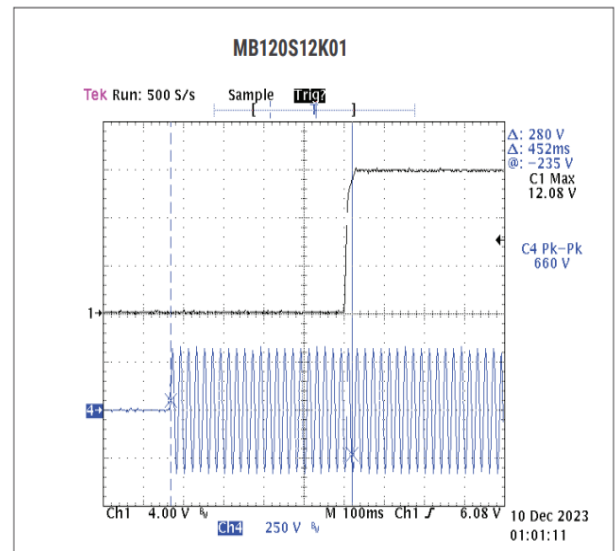

Fig. 05: TURN-ON DELAY AT 230VAC – 10A LOAD.

PERFORMANCE DATA

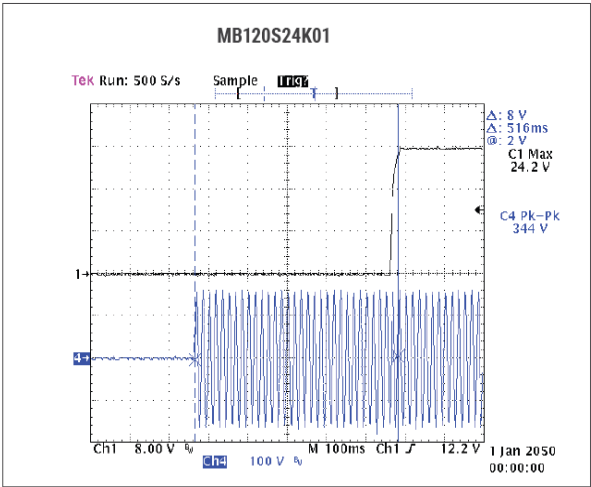

Fig. 06: TURN-ON DELAY AT 115VAC – 10A LOAD.

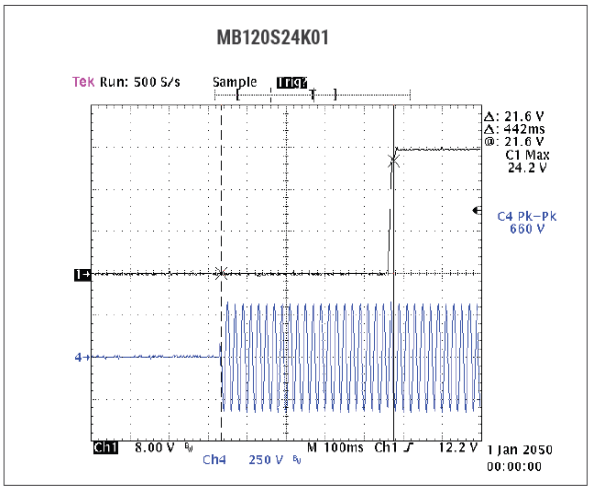

Fig. 07: TURN-ON DELAY AT 230VAC – 10A LOAD.

Output Turn-On Rise Time

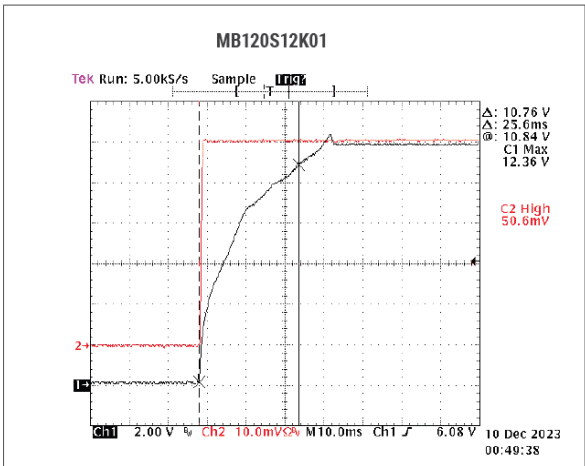

Fig. 08: TURN-ON RISE TIME AT 90VAC – 10A LOAD.

CH1: Vout,
CH2: 2A/10mV.

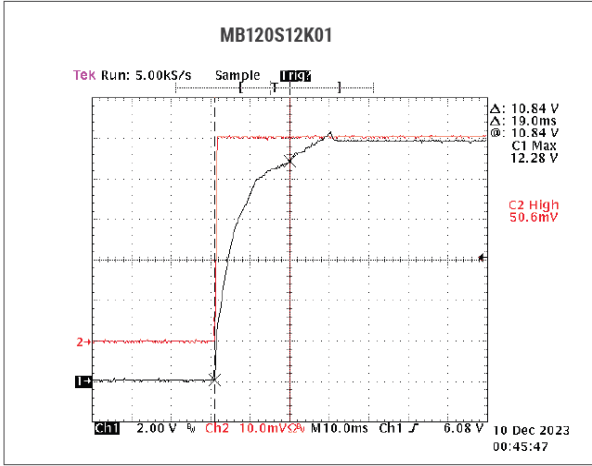

Fig. 09: TURN-ON RISE TIME AT 264VAC – 10A LOAD.

CH1: Vout,
CH4: 2A/10mV.

PERFORMANCE DATA

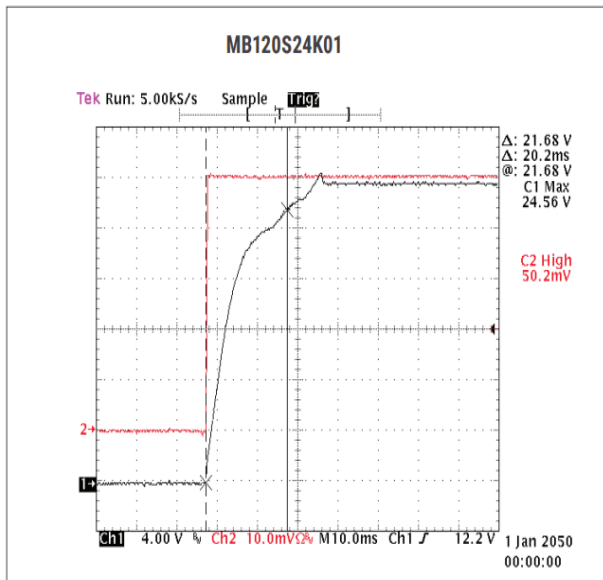

Fig. 10: TURN-ON RISE TIME AT 90VAC - 5A LOAD.

CH1: Vout,
 CH4: 1A/10mV.

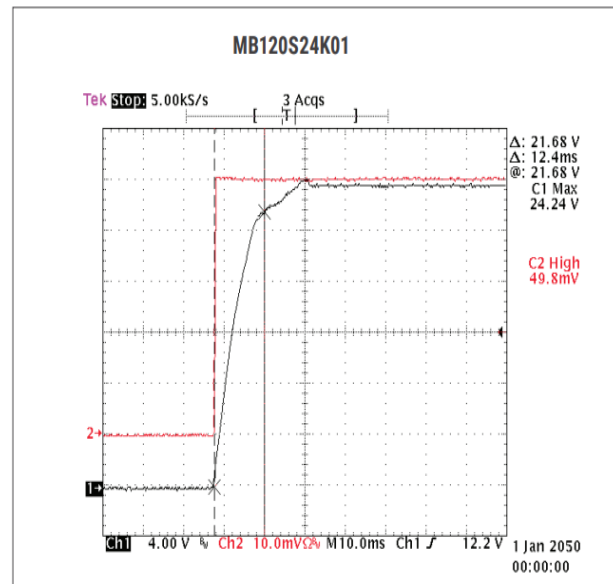

Fig. 11: TURN-ON RISE TIME AT 264VAC - 5A LOAD.

CH1: Vout,
 CH4: 1A/10mV.

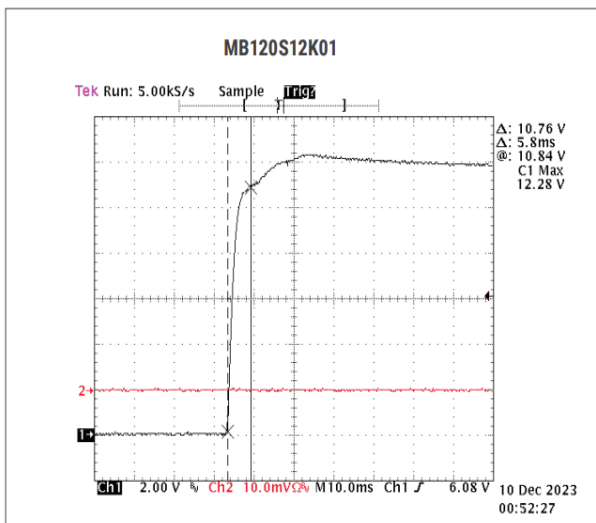

Fig. 12: TURN-ON RISE TIME AT 90VAC - NO LOAD.

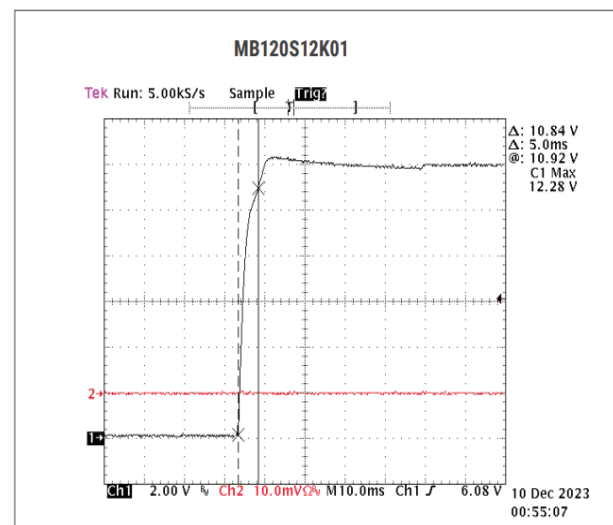

Fig. 13: TURN-ON RISE TIME AT 264VAC - NO LOAD.

PERFORMANCE DATA

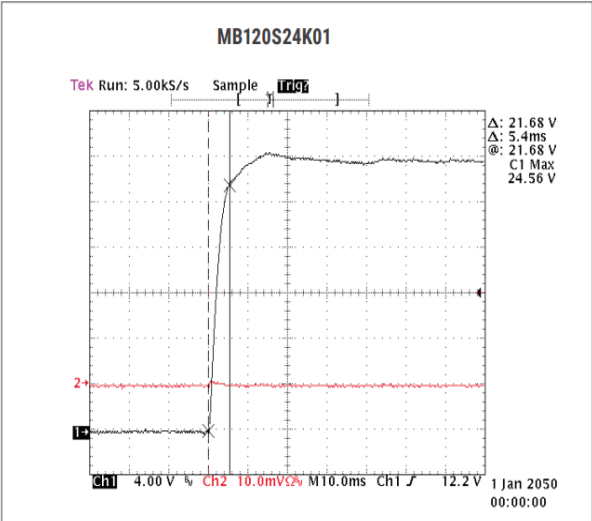

Fig. 14: TURN-ON RISE TIME AT 90VAC – NO LOAD.

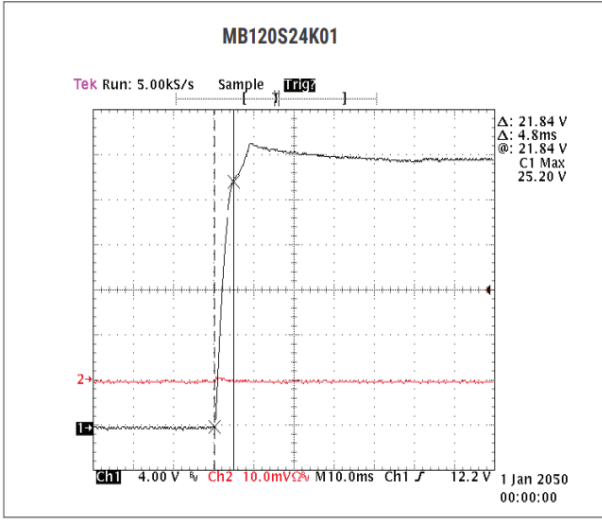

Fig. 15: TURN-ON RISE TIME AT 264VAC – NO LOAD.

Hold-Up Time

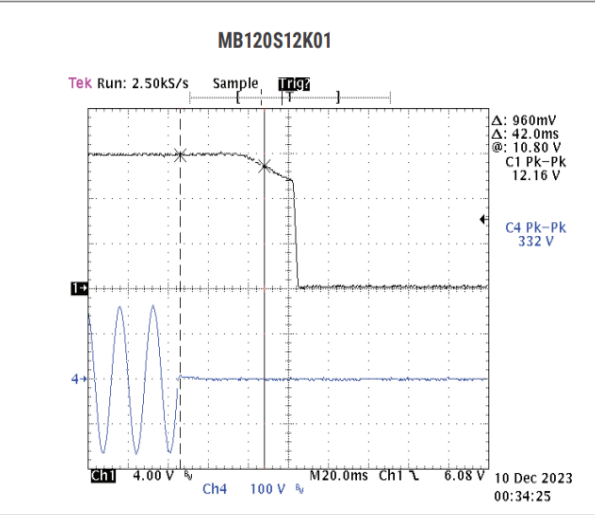

Fig. 16: HOLD-UP TIME AT 90VAC – 5A LOAD (1A/10mV).

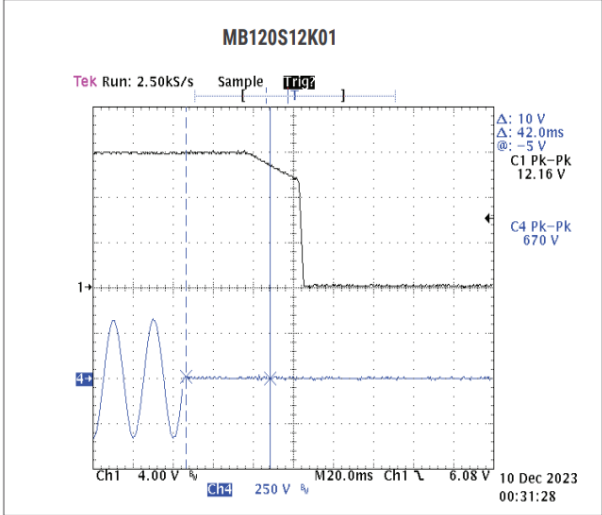

Fig. 17: HOLD-UP TIME AT 264VAC – 5A LOAD (1A/10mV).

PERFORMANCE DATA

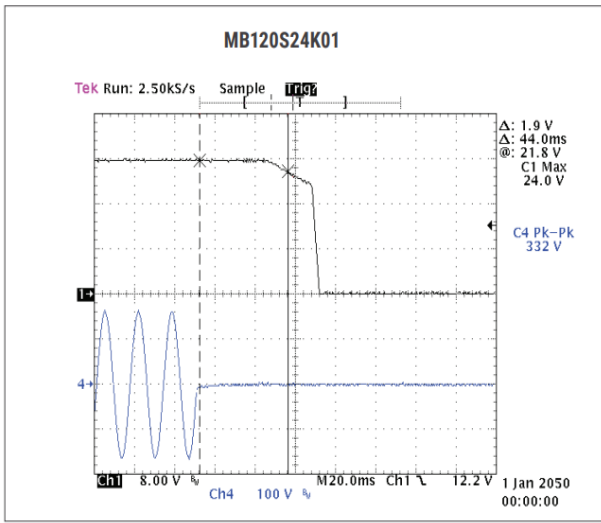

Fig. 18: HOLD-UP TIME FROM LOSS OF AC AT 115VAC – 5A LOAD.

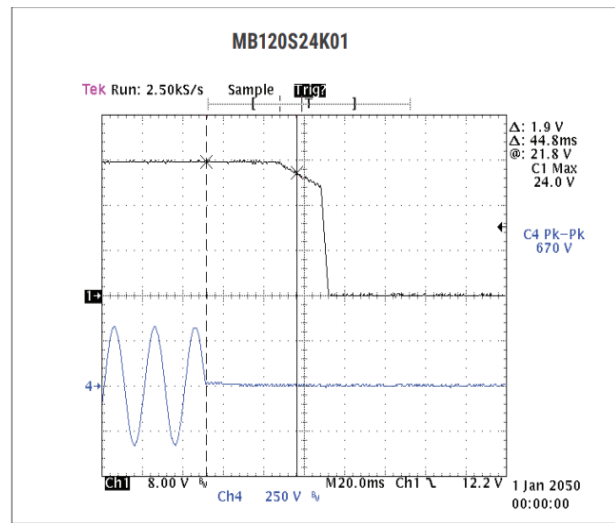

Fig. 19: HOLD-UP TIME FROM LOSS OF AC AT 230VAC – 5A LOAD.

Output Over-Load Protection

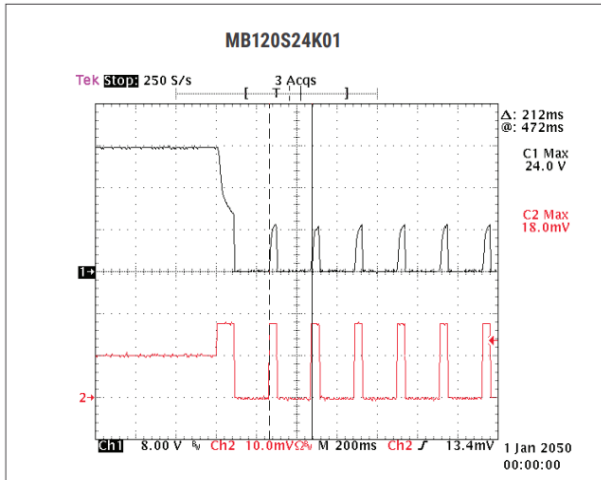

Fig. 20: OUTPUT OVER LOAD AT 115VAC.

CH1: Vout,
 CH2: Over Load Current (5A/10mV).

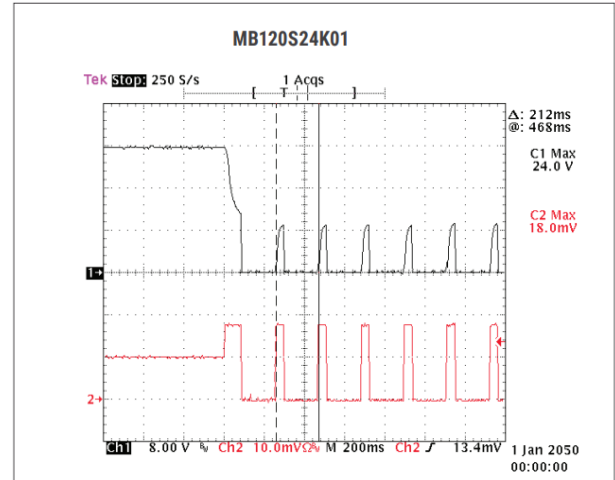

Fig. 21: OUTPUT OVER LOAD AT 230VAC.

CH1: Vout,
 CH2: Over Load Current(5A/10mV).

PERFORMANCE DATA

Output Short-Circuit Protection

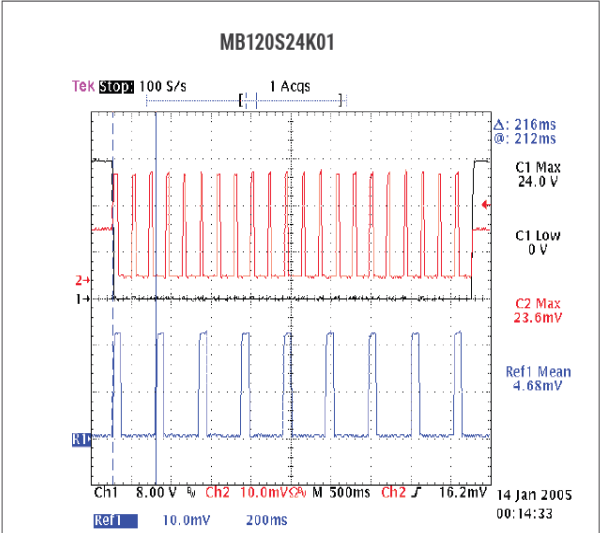

Fig. 22: OUTPUT SHORT CIRCUIT AT 115VAC.

CH1: Vout,
CH2: Short Circuit Current (5A/10mV).

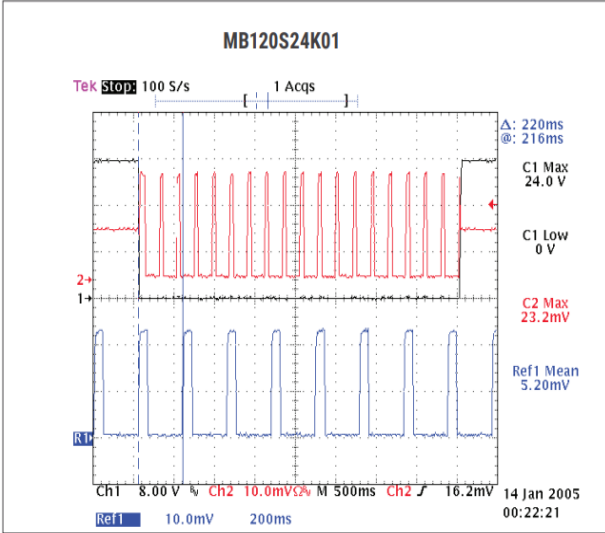

Fig. 23: OUTPUT SHORT CIRCUIT AT 230VAC.

CH1: Vout,
CH2: Short Circuit Current (5A/10mV).

Output Return Shorted to Ground Common Mode Current

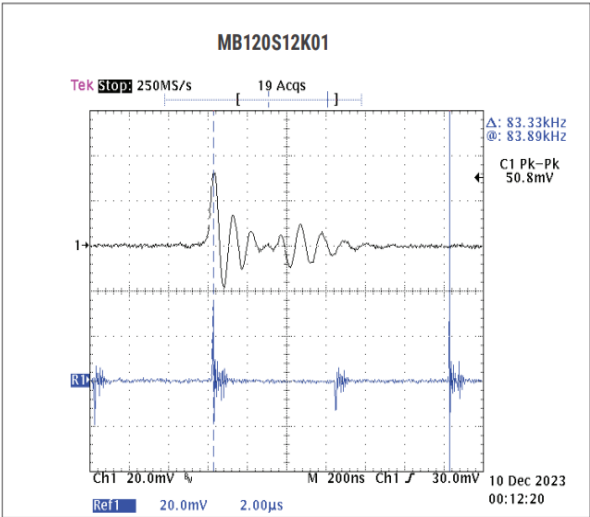

Fig. 26: COMMON MODE CURRENT AT 115VAC.

CURRENT PROBE: 1mA/mV.

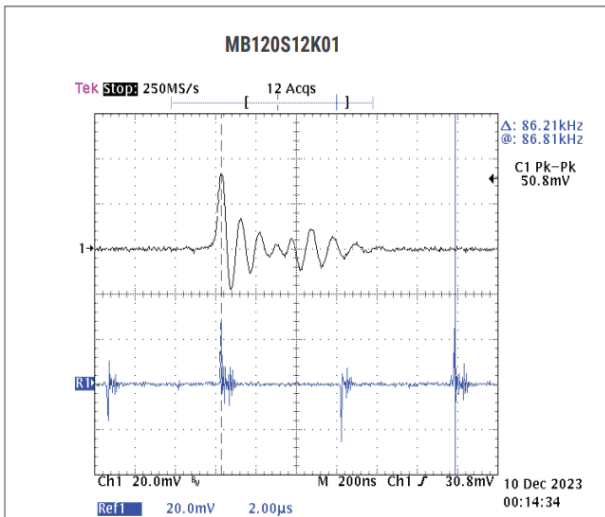

Fig. 27: COMMON MODE CURRENT AT 230VAC.

CURRENT PROBE: 1mA/mV.

PERFORMANCE DATA

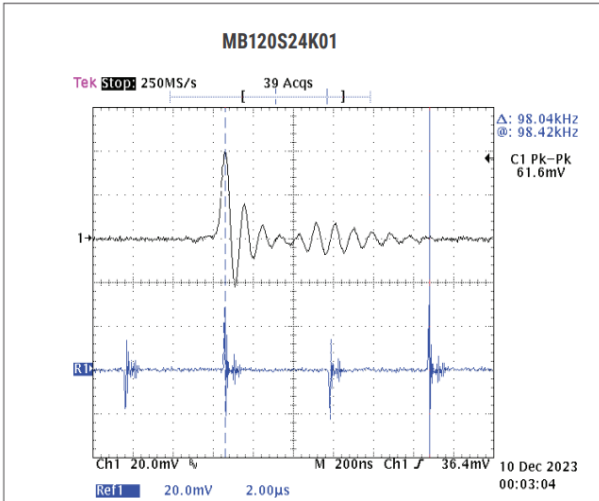

Fig. 28: COMMON MODE CURRENT AT 115VAC.
CURRENT PROBE: 1mA/mV.

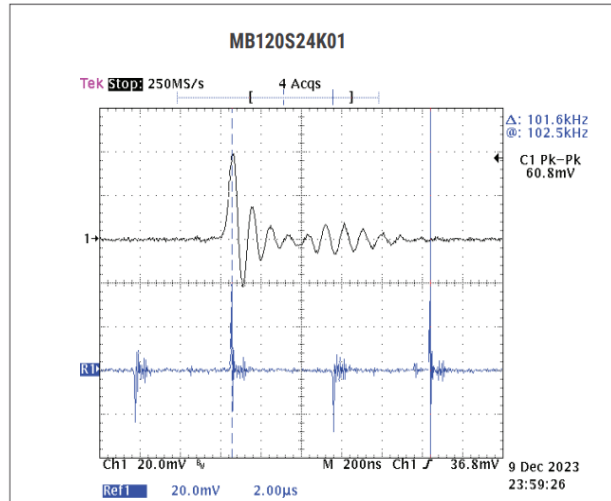

Fig. 29: COMMON MODE CURRENT AT 230VAC.
CURRENT PROBE: 1mA/mV.

Conducted Emissions

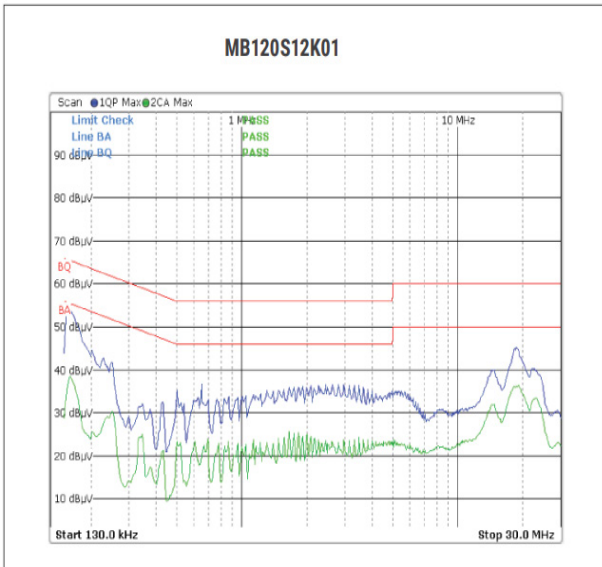

Fig. 30: EN55032 CLASS B – 230V/50Hz 100% LOAD MARGIN: >10 dB.

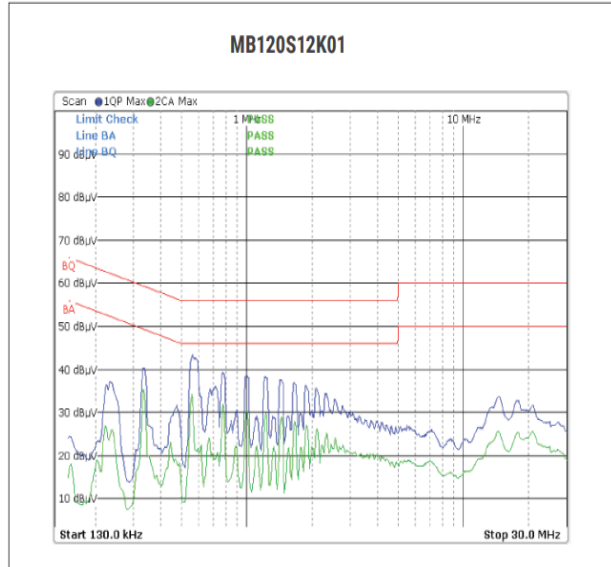

Fig. 31: EN55032 CLASS B – 230V/50Hz 10% LOAD MARGIN: >10 dB.
Blue Plot: Quasi-Peak. Red Plot: Average.

PERFORMANCE DATA

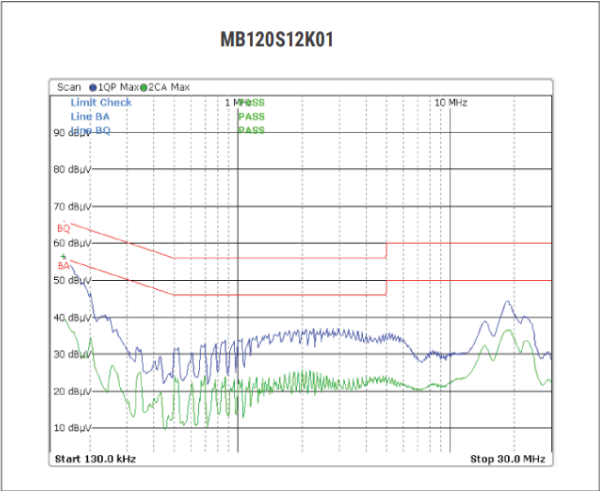

Fig. 32: EN55032 CLASS B – 115V/60Hz 100% LOAD MARGIN: 9 dB.
Blue Plot: Quasi-Peak. Red Plot: Average.

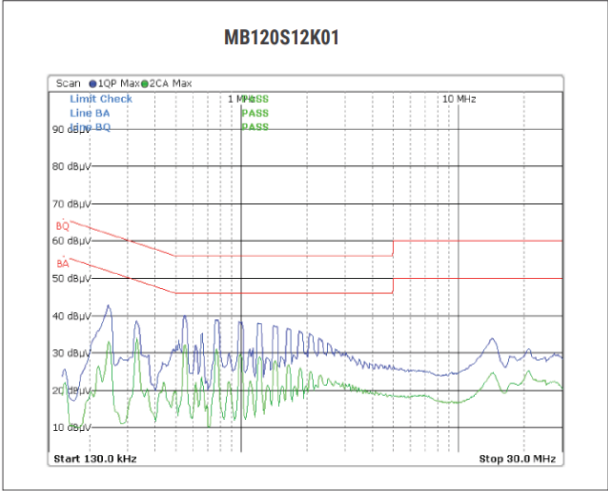

Fig. 33: EN55032 CLASS B – 115V/60Hz 10% LOAD MARGIN: >10 dB.
Blue Plot: Quasi-Peak. Red Plot: Average.

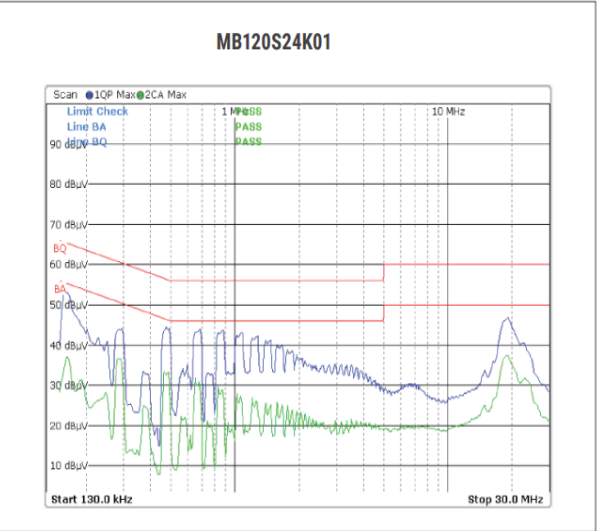

Fig. 34: EN55032 CLASS B – 230V/50Hz 100% LOAD MARGIN: >10 dB.
Blue Plot: Quasi-Peak. Red Plot: Average.

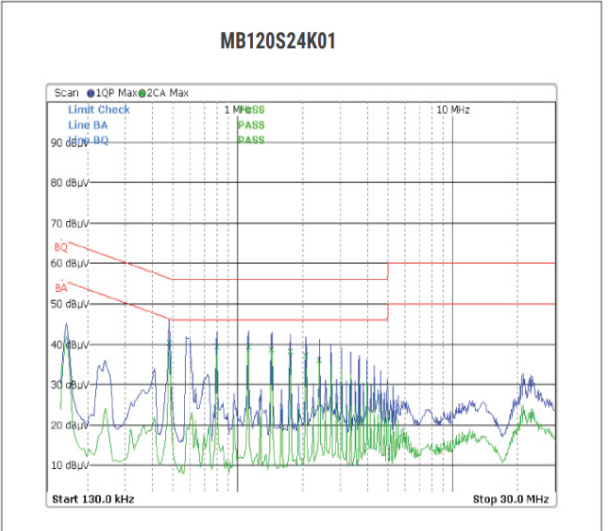

Fig. 35: EN55032 CLASS B – 230V/50Hz 10% LOAD MARGIN: >10 dB.
Blue Plot: Quasi-Peak. Red Plot: Average.

PERFORMANCE DATA

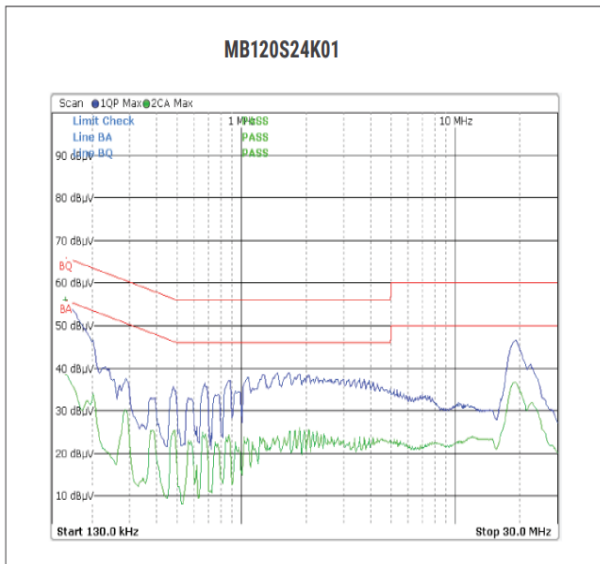

Fig. 36: EN55032 CLASS B – 115V/60Hz 100% LOAD MARGIN: >9 dB.
Blue Plot: Quasi-Peak. Red Plot: Average.

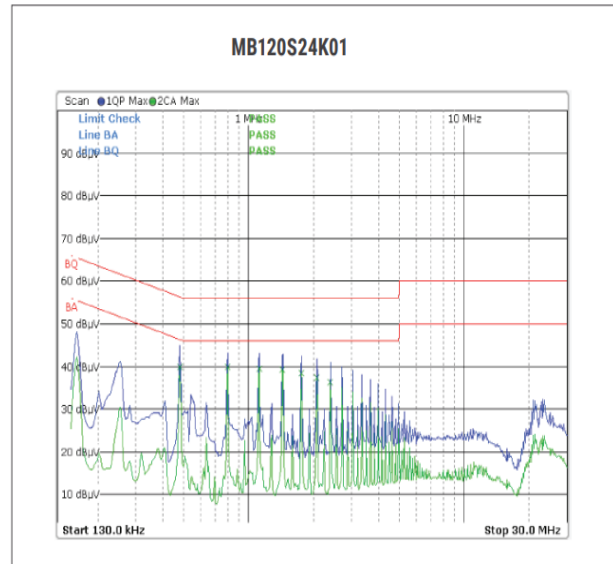

Fig. 37: EN55032 CLASS B – 115V/60Hz 10% LOAD MARGIN: >10 dB.
Blue Plot: Quasi-Peak. Red Plot: Average.



For international contact information,
visit advancedenergy.com.

powersales@aei.com (Sales Support)
productsupport.ep@aei.com (Technical Support)
+1 888 412 7832

ABOUT ADVANCED ENERGY

Advanced Energy (AE) has devoted more than three decades to perfecting power for its global customers. AE designs and manufactures highly engineered, precision power conversion, measurement and control solutions for mission-critical applications and processes.

Our products enable customer innovation in complex applications for a wide range of industries including semiconductor equipment, industrial, manufacturing, telecommunications, data center computing, and medical. With deep applications know-how and responsive service and support across the globe, we build collaborative partnerships to meet rapid technological developments, propel growth for our customers, and innovate the future of power.

PRECISION | POWER | PERFORMANCE | TRUST

Specifications are subject to change without notice. Not responsible for errors or omissions. ©2023 Advanced Energy Industries, Inc. All rights reserved. Advanced Energy®, AE® and SL Power™ are U.S. trademarks of Advanced Energy Industries, Inc.