

ARTESYN

ADQ600-48S10-4L

625 Watts Quarter Brick Converter



PRODUCT DESCRIPTION

Advanced Energy's Artesyn ADQ600-48S10-4L is a single output DC-DC converter with standard quarter-brick outline and pin configuration. It delivers up to 63A output current with 10.1V output voltage. Ultra-high 97.0% efficiency and excellent thermal performance makes it an ideal choice for use in datacom and telecommunication applications and can work under $-40^{\circ}\text{C} \sim +85^{\circ}\text{C}$.

AT A GLANCE

Total Power

625 Watts

Input Voltage

45 to 56 Vdc

of Outputs

Single

SPECIAL FEATURES

- Delivering up to 63A output
- Ultra-high efficiency 97.0% typ. at 80% load
- Wide input range: 45V to 56V
- Startup Pre-bias
- Parallel with droop current sharing
- Excellent thermal performance
- No minimum load requirement
- RoHS 3.0
- Remote control function
- Input under voltage lockout
- Input over voltage lockout
- Output over current protection
- Output over voltage protection
- Over temperature protection
- Industry standard quarter-brick pin-out outline
- Open-frame and baseplated
- Pin length option: 4.8mm

SAFETY

- UL/TUV EN62368/IEC60950
- UL/CB IEC60950
- UL94,V-0
- CE and UKCA Mark

TYPICAL APPLICATIONS

- Telecom
- Datacom



MODEL NUMBERS

Standard	Output Voltage	Structure	Structure	ROHS
ADQ600-48S10-4L	10Vdc	Open-frame	Negative	RoHS3.0
ADQ600-48S10B-4L	10Vdc	Baseplated	Negative	RoHS3.0

Order Information

ADQ600	-	48	S	12	B	-	6	L
①		②	③	④	⑤		⑥	⑦

①	Model series	ADQ: high efficiency quarter brick series, 600: output power 625W
②	Input voltage	48: 45V ~ 56V input range, rated input voltage 48V
③	Output number	S: single output
④	Rated output voltage	10: 10V output
⑤	Baseplate	B: with baseplate; default: open frame
⑥	Pin length	4: 4.6mm ± 0.25mm pin length
⑦	RoHS status	RoHS 3.0

Options

None

ELECTRICAL SPECIFICATIONS

Absolute Maximum Ratings

Stress in excess of those listed in the “Absolute Maximum Ratings” may cause permanent damage to the power supply. These are stress ratings only and functional operation of the unit is not implied at these or any other conditions above those given in the operational sections of this TRN. Exposure to any absolute maximum rated condition for extended periods may adversely affect the power supply’s reliability.

Table 1. Absolute Maximum Ratings						
Parameter	Model	Symbol	Min	Typ	Max	Unit
Input Voltage Operating –Continuous Non-operating 100ms	All	$V_{IN,DC}$	- -	- -	60 80	Vdc Vdc
Maximum Output Power	All	$P_{O,max}$	-	-	625	W
Isolation Voltage ¹ Input to output	All		-	-	750	Vdc
Ambient Operating Temperature	All	T_A	-20	-	+90	°C
Storage Temperature	All	T_{STG}	-55	-	+125	°C
Voltage at remote ON/OFF pin	All		-	-	20	Vdc

Note: 1 - 1mA for 5s.

ELECTRICAL SPECIFICATIONS

Input Specifications

Table 2. Input Specifications						
Parameter	Conditions ¹	Symbol	Min	Typ	Max	Unit
Operating Input Voltage, DC	All	$V_{IN,DC}$	45	48	56	Vdc
Turn-on Voltage Threshold	$I_O = I_{O,max}$	$V_{IN,ON}$	-	-	45	Vdc
Turn-off Voltage Threshold	$I_O = I_{O,max}$	$V_{IN,OFF}$	-	-	42.5	Vdc
Lockout Voltage Hysteresis	$I_O = I_{O,max}$		2	-	-	V
Input OVP	$I_O = I_{O,max}$	V_{IN}	60	-	64	V
Input recovery voltage	$I_O = I_{O,max}$	V_{IN}	57	-	63	V
Maximum Input Current ($I_O = I_{O,max}$)	$V_{IN,DC} = 45Vdc$	$I_{IN,max}$	-	-	15.3	A
No Load Input Current	$I_O = 0A$	I_{IN}	-	135	-	mA
Standby Input Current	Remote Off	I_{IN}	-	20	-	mA
Inrush current			-	-	5.8 ²	A
Recommended Input Fuse	Fast blow external fuse recommended		-	-	25	A
Recommended External Input Capacitance	Low ESR capacitor recommended	C_{IN}	120	-	600	uF
Input Ripple Current	Through 12uH inductor		-	-	625	mA
Input Filter Component Value(C\L)	Internal values		-	9.4\1.2	-	uF\muH
Operating Efficiency	$T_A = 25\text{ }^\circ\text{C}$ $I_O = I_{O,max}$ $I_O = 80\%I_{O,max}$	η	-	96.9 ³	-	%
			-	97 ³	-	%

Note 1 - $T_A = 25\text{ }^\circ\text{C}$, airflow rate = 400 LFM, $V_{in} = 48Vdc$, nominal V_{out} unless otherwise noted.

Note 2 - Inrush Current is defined as the peak current drawn by the unit when unit is enabled after V_{in} is present. While V_{out} is rising, P_{out} is <25% of Rated Power with a resistive load

Note 3 - Air velocity: 600LFM

ELECTRICAL SPECIFICATIONS

Output Specifications

Table 3. Output Specifications							
Parameter	Conditions ¹	Symbol	Min	Typ	Max	Unit	
Factory Set Voltage	$V_{IN,DC} = 48Vdc$ $I_O = I_{O,max}$	V_O	10.05	10.10	10.15	Vdc	
Total Regulation	Inclusive of line, load temperature change, warm-up drift	V_O	9.6	-	11.2	Vdc	
Output Voltage Line Regulation	All	$\pm V_O$	-	40	50	mV	
Output Voltage Load Regulation	All	$\pm V_O$	-	200	400	mV	
Output Voltage Temperature Regulation	All	$\%V_O$	-	0.002	0.02	$\%/^{\circ}C$	
Output Ripple, pk-pk	Measure with a 750uF output capacitor to 20MHz bandwidth	V_O	-	-	150	mV_{PK-PK}	
Output Current	All	I_O	0	-	63	A	
Output DC current-limit inception ²		I_O	110	-	140	$\%I_{O,max}$	
V_O Load Capacitance for Single Module	All	C_O	-	-	4500 ³	μF	
V_O Load Capacitance for Parallel Condition	All	C_O	-	-	9000 ⁴	μF	
V_O Dynamic Response	Peak Deviation Settling Time	$25\% \sim 50\% \sim 25\% I_{O,max}$ slew rate = 1A/us	$\pm V_O$ T_s	- -	- -	350 500	mV uSec
		$50\% \sim 75\% \sim 50\% I_{O,max}$ slew rate = 0.1A/us	$\pm V_O$ T_s	- -	- -	350 200	mV uSec
Turn-on transient	Rise time in non-pre-bias condition	$I_O = I_{O,max}$	T_{rise}	-	-	15	mS
	Rise time in pre-bias condition	$I_O = I_{O,max}$	T_{rise}			40	mS
	Turn-on delay time-1 in non-pre-bias condition	$I_O = I_{O,max}$	$T_{turn-on}$	-	-	30	mS
	Turn-on delay time-1 in pre-bias condition or parallel condition	$I_O = I_{O,max}$	$T_{turn-on}$	-	-	40	mS
	Turn-on delay time-2 in non-pre-bias condition	$I_O = I_{O,max}$	$T_{turn-on}$			5	mS
	Turn-on delay time-2 in pre-bias condition or parallel condition	$I_O = I_{O,max}$	$T_{turn-on}$			30	mS
	Turn-On overshoot	$I_O = 0$				350	mV
	Turn-Off Undershoot	$I_O = 0$				350	mV

ELECTRICAL SPECIFICATIONS

Output Specifications

Table 3. Output Specifications Con't						
Parameter	Conditions	Symbol	Min	Typ	Max	Unit
Switching frequency	All	f_{sw}	-	160	-	KHz
Remote ON/OFF control (Negative logic)	Off-state voltage		2.4	-	20	V
	On-state voltage		0.3	-	0.8	V
	Current (out of pin) On		-	-	200	μ A
	Current(out of pin) Off		10	-	-	μ A
	Enable Pin Open-Circuit Voltage		-	-	20	V
	Enable Pin Current (into pin, ext. pull-up to 15V)		-	-	0.5	mA
	Enable Pin Current (into pin, ext. pull-up to 10V)		-	-	0.3	mA
V_O Current Share Accuracy	10% to 240% $I_{O,max}$		-	-	10%	% $I_{O,max}$
Number of Parallel Units			-	-	3	
Pre-bias		% V_O	0	-	100	%
Output over-voltage protection ⁵	All		12	-	14	V
Output over-temperature protection ⁶	All	T	-	-	140	$^{\circ}$ C
Over-temperature hysteresis	All	T	5	-	-	$^{\circ}$ C
MTBF	Telcordia SR-332 Method 1 Case 1 40 $^{\circ}$ C T_A		-	2	-	10^6 h

Note 1 - $T_A = 25^{\circ}$ C, airflow rate = 400 LFM, $V_{in} = 48$ Vdc, nominal V_{out} unless otherwise noted.

Note 2 - Hiccup: auto-restart when over-current condition is removed.

Note 3 - Approximately 50% ceramic, 50% Oscon parallel POSCAP

Note 4 - OSCON or POSCAP

Note 5 - Hiccup: auto-restart when over-voltage condition is removed.

Note 6 - Auto recovery.

ELECTRICAL SPECIFICATIONS

ADQ600-48S10-4L Performance Curves

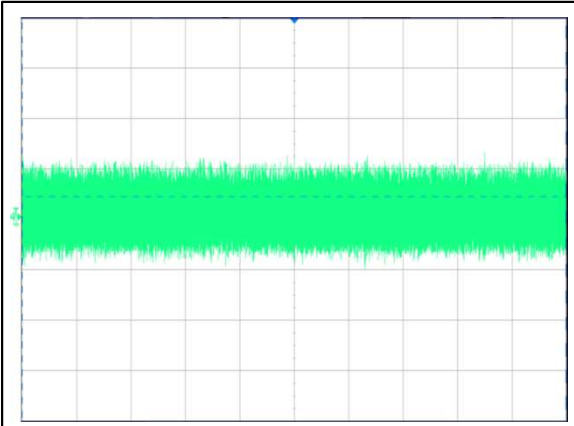

Figure 1: ADQ600-48S10-4L Input Ripple Current Waveform

Ch1 : Iin (10mS/div, 1.0A/div)

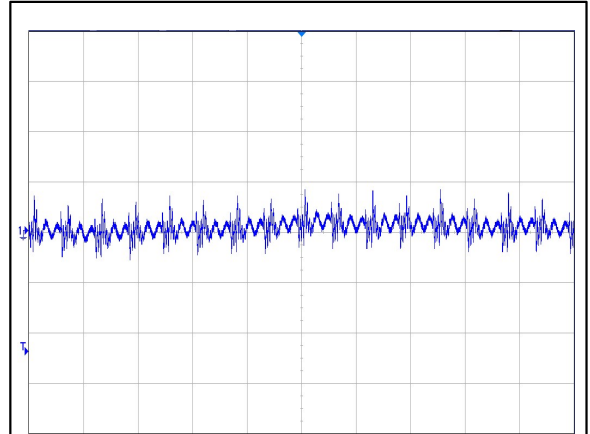

Figure 2: ADQ600-48S10-4L Ripple and Noise Measurement

Ch1 : Vo (5uS/div, 50mV/div)

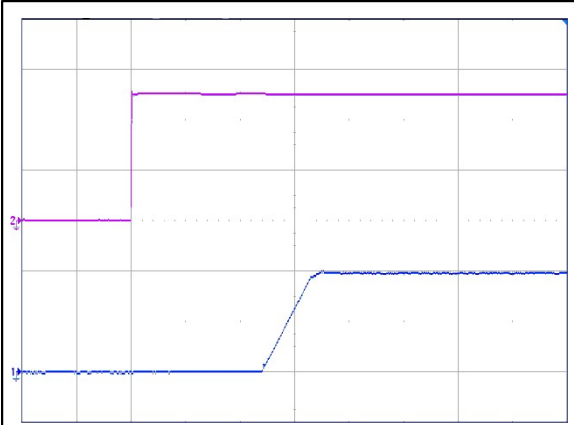

Figure 3: ADQ600-48S10-4L Startup Characteristic(10mS/div)

Ch 1: Vo (5V/div) Ch 2: Vin (20V/div)

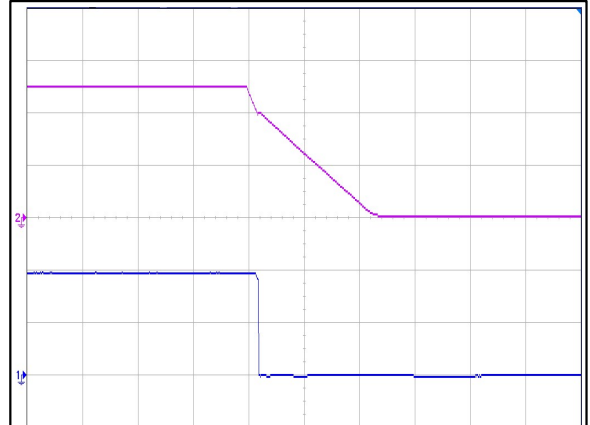

Figure 4: ADQ600-48S10-4L Turn Off Characteristic (50mS/div)

Ch 2: Vo (5V/div) Ch 3: Vin (20V/div)

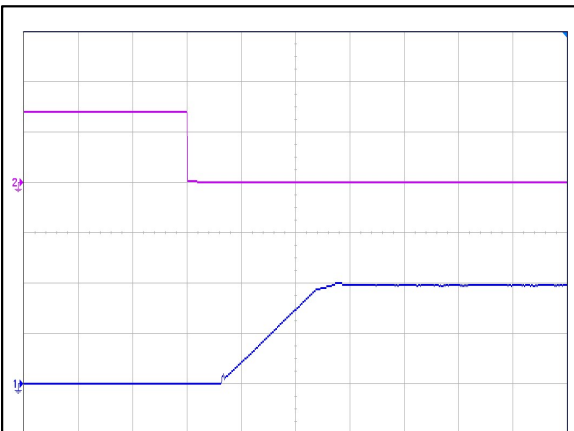

Figure 5: ADQ600-48S10-4L Remote ON Waveform (5mS/div)

Ch 1: Vo (5V/div) Ch 2: Remote ON (2V/div)

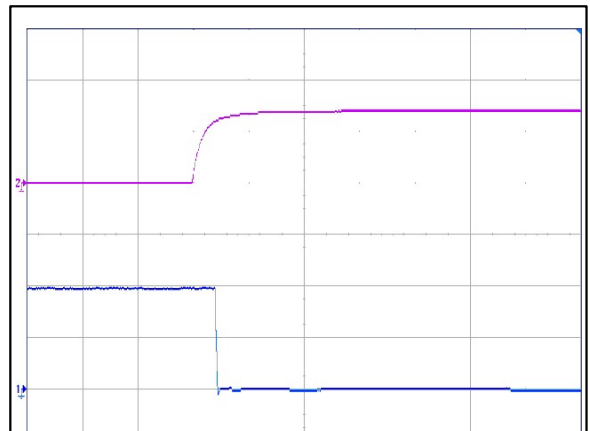

Figure 6: ADQ600-48S12-6L Remote OFF Waveform (5mS/div)

Ch 1: Vo (5V/div) CH2: Remote OFF (2V/div)

ELECTRICAL SPECIFICATIONS

ADQ600-48S10-4L Performance Curves

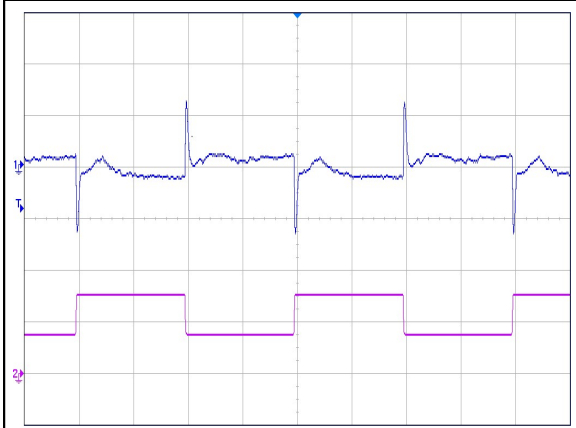

Figure 7: ADQ600-48S10-4L Transient Response (2mS/div)
 25% load step(50%-75%-50%)
 Ch 1: Vo (100mV/div) Ch 2: Io (20A/div)

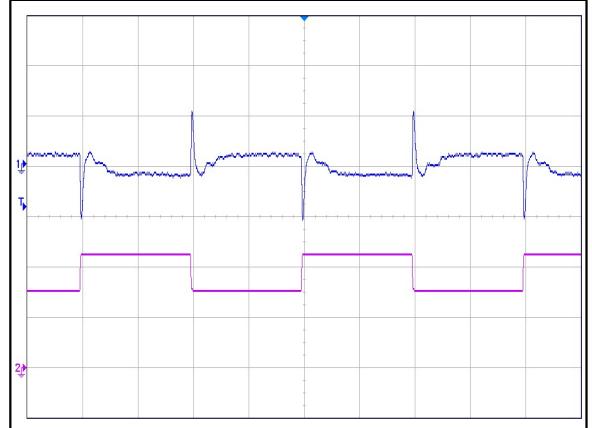

Figure 8: ADQ600-48S10-4L Transient Response (2mS/div)
 50% load step(50%-75%-50%)
 Ch 1: Vo (100mV/div) Ch 2: Io (20A/div)

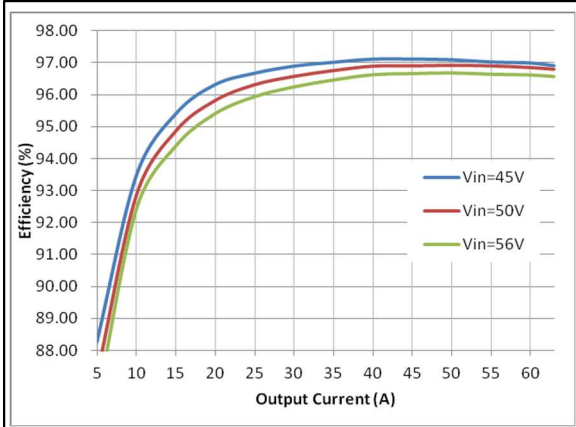
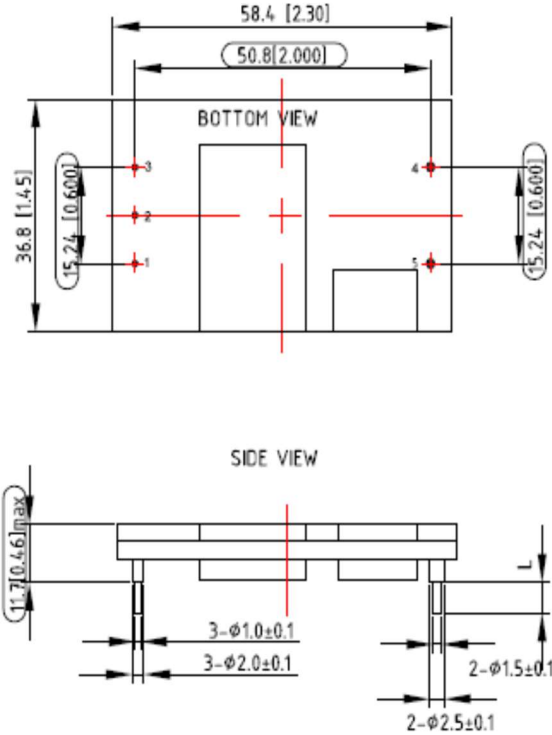

Figure 9: ADQ600-48S10-4L Efficiency Curves @ 25 OC
 Loading: Io = 10% increment to 63A

MECHANICAL SPECIFICATIONS

Mechanical Outlines – Open Frame Module



UNIT: mm[inch] BOTTOM VIEW: pin on upside L=4.60mm

UNIT: mm[inch]
 TOLERANCE: X.X mm ± 0.5 mm [X.XX in. ± 0.02 in.]
 X.XX mm ± 0.25 mm [X.XXX in. ± 0.01 in.]

MECHANICAL SPECIFICATIONS

Mechanical Outlines – Baseplate Module

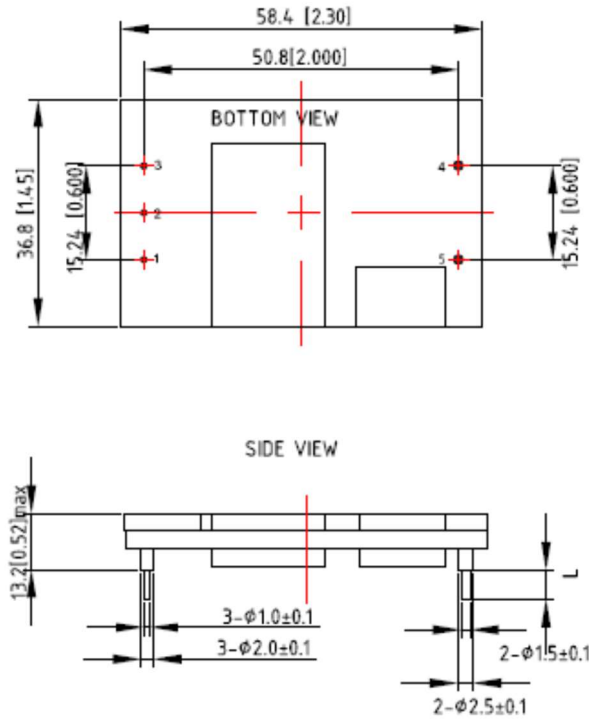

UNIT: mm[inch]

BOTTOM VIEW: pin on upside

L=4.60mm

UNIT: mm[inch]

TOLERANCE: X.X mm±0.5 mm[X.XX in. ±0.02 in.]

X.XX mm±0.25 mm[X.XXX in. ±0.01 in.]

Note: Depth penetration into base plate, of M3 screws used at baseplate mounting holes, not to exceed maximum of 3.0mm.

Pin length option

Table 4. Pin length option	
Device code suffix	L
-4	4.8mm±0.25 mm
-6	3.8mm±0.25 mm
-8	2.8mm±0.25 mm
None	5.8mm±0.25 mm

MECHANICAL SPECIFICATIONS

Pin Designations

Pin No	Name	Function
1	Vin+	Positive input voltage
2	Remote On/Off	Remote control(Enable)
3	Vin-	Negative input voltage
4	Vo-	Negative output voltage
5	Vo+	Positive output voltage

ENVIRONMENTAL SPECIFICATIONS

EMC Immunity

ADQ600-48S10-4L power supply is designed to meet the following EMC immunity specifications:

Table 5. Environmental Specifications:		
Document	Description	Criteria
EN55022, Class B Limits	Conducted and Radiated EMI Limits, DC input port	/
IEC/EN 61000-4-2, Level 4	Electromagnetic Compatibility (EMC) - Testing and measurement techniques: Electrostatic discharge immunity test	B
IEC/EN 61000-4-4, Level3	Electromagnetic Compatibility (EMC) - Testing and measurement techniques: Electrical Fast Transient. DC input port.	B
IEC/EN 61000-4-5	Electromagnetic Compatibility (EMC) - Testing and measurement techniques: Immunity to surges - 600V common mode and 600V differential mode for DC port	B
IEC/EN 61000-4-6, Level 2	Electromagnetic Compatibility (EMC) - Testing and measurement techniques: Continuous Conducted Interference. DC input port	A
EN61000-4-29	Electromagnetic Compatibility (EMC) - Testing and measurement techniques: Voltage Dips and short interruptions and voltage variations. DC input port	B

Criterion A: Normal performance during and after test.

Criterion B: For EFT and surges, low-voltage protection or reset is not allowed. Temporary output voltage fluctuation ceases after disturbances ceases, and from which the EUT recovers its normal performance automatically.

For Dips and ESD, output voltage fluctuation or reset is allowed during the test, but recovers to its normal performance automatically after the disturbance ceases.

Criterion C: Temporary loss of output, the correction of which requires operator intervention.

Criterion D: Loss of output which is not recoverable, owing to damage to hardware.

Recommend EMC Filter Configuration

See Figure 28.

ENVIRONMENTAL SPECIFICATIONS

Safety Certifications

The ADQ600-48S10-4L power supply is intended for inclusion in other equipment and the installer must ensure that it is in compliance with all the requirements of the end application. This product is only for inclusion by professional installers within other equipment and must not be operated as a stand alone product.

Table 6. Safety Certifications for ADQ600-48S10-4L power supply system

Standard	Agency	Description
UL 60950-1, 2nd, 2014-10-14, UL 62368-1, 2nd Edition:2014, CSA C22.2 No. 62368-1, 2 nd Edition:2014	UL+CUL	US and Canada Requirements
EN 62368-1:2014	TUV-SUD	Europe Requirements
EN 60950-1:2006/A2:2013	TUV-SUD	Europe Requirements
IEC 62368-1 (ed. 2)	UL+CB	International Requirements
CE		CE Marking
UKCA Mark		UK Requirements

ENVIRONMENTAL SPECIFICATIONS

Operating Temperature

The ADQ600-48S10-4L supplies will start and operate within stated specifications at an ambient temperature from -20 °C to 90 °C under all load conditions. The storage temperature is -55 °C to 125 °C

Thermal Considerations - Open-Frame (ADQ600-48S10-4L)

The converter is designed to operate in different thermal environments and sufficient cooling must be provided. Proper cooling can be verified by measuring the temperature at the test point as shown in the Figure 10. The temperature at this point should not exceed the max values in the table 6.

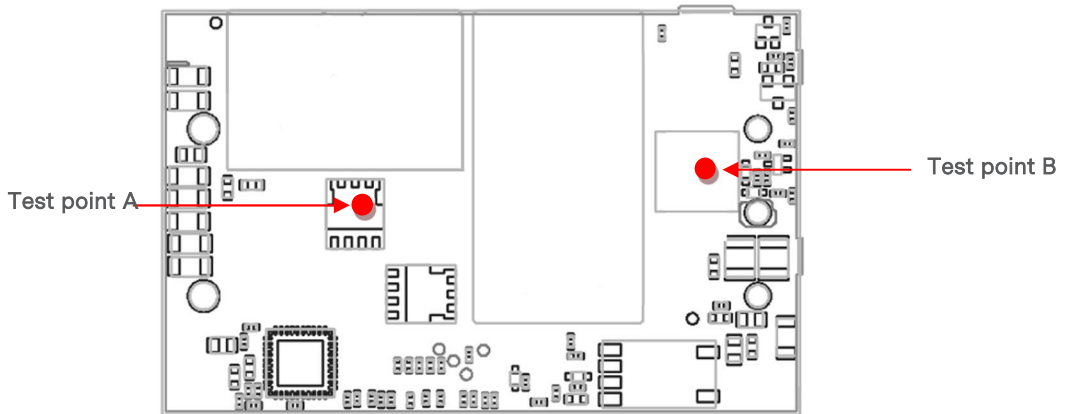

Figure 10 Temperature test point

Table 6. Temperature limit of the test point	
Test Point	Temperature limit
Test point 1	122 °C
Test point 2 (PCB)	128 °C

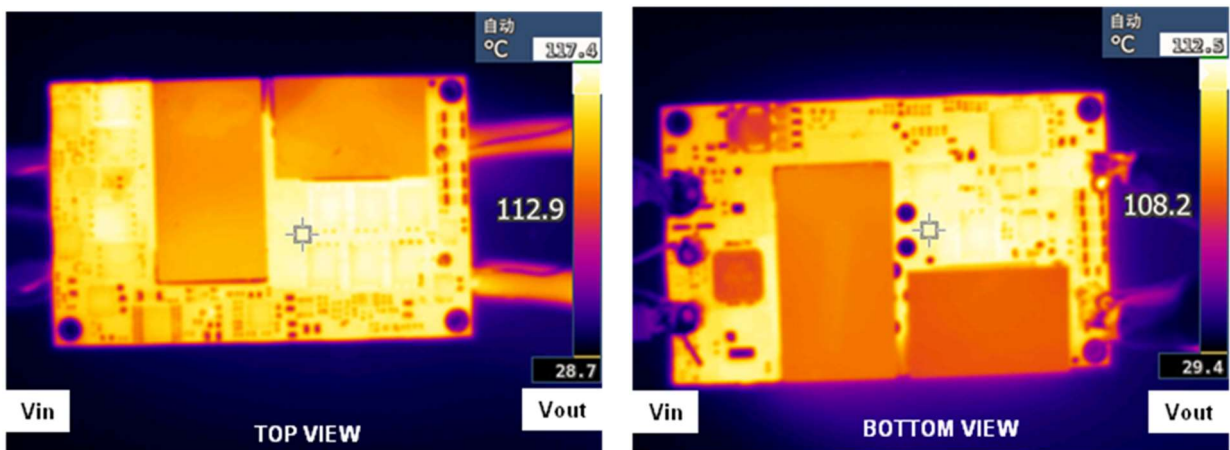

Figure 11 Thermal image, test at 56V_{in}, full load, room temperature

ENVIRONMENTAL SPECIFICATIONS

Open-frame unit and Base-plate unit longitudinal Thermal De-rating data

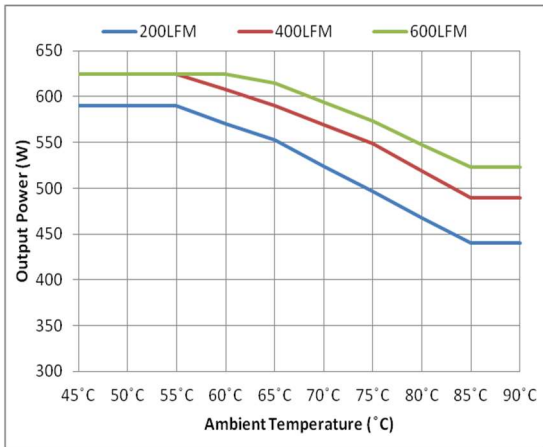
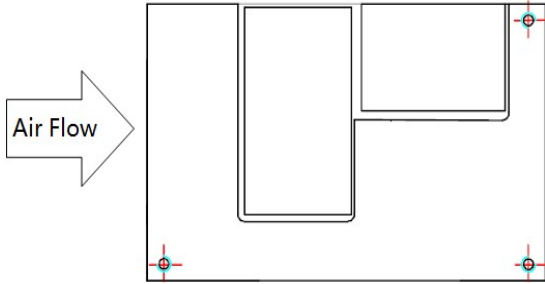

Figure 12 Thermal De-rating Data of Open-frame module

Test at 45V_{in}, longitudinal airflow from V_{in} to V_{out}

Base-plate unit with 0.61" heat-sink longitudinal Thermal De-rating data

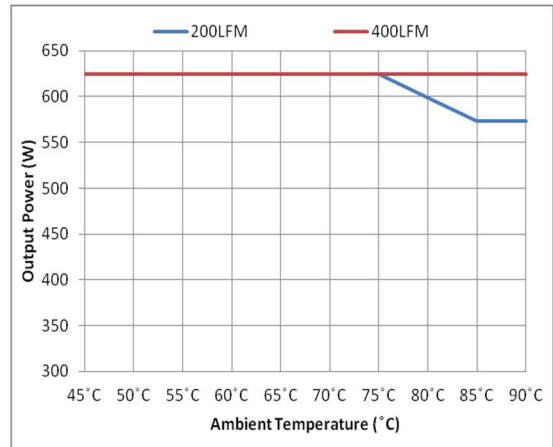
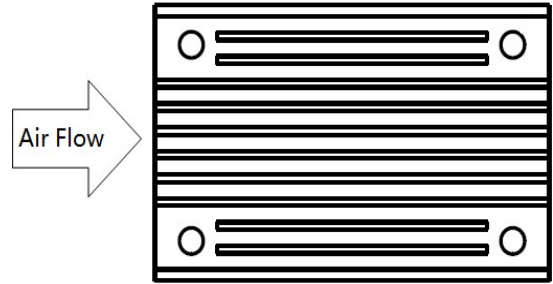

Figure 13 Thermal De-rating Data of Base-plate module with 0.61" Heat-sink

Test at 45V_{in}, longitudinal airflow from V_{in} to V_{out}

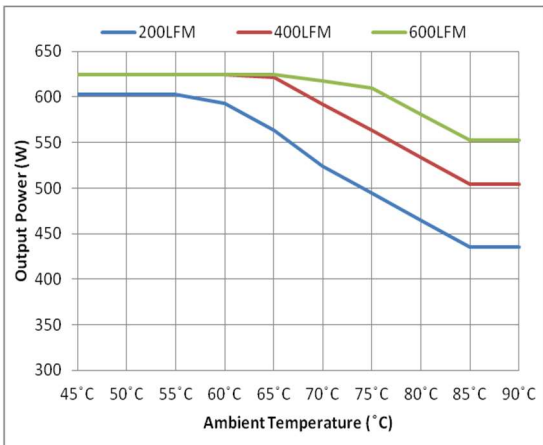

Figure 14 Thermal De-rating Data of Open-frame module

Test at 50V_{in}, longitudinal airflow from V_{in} to V_{out}

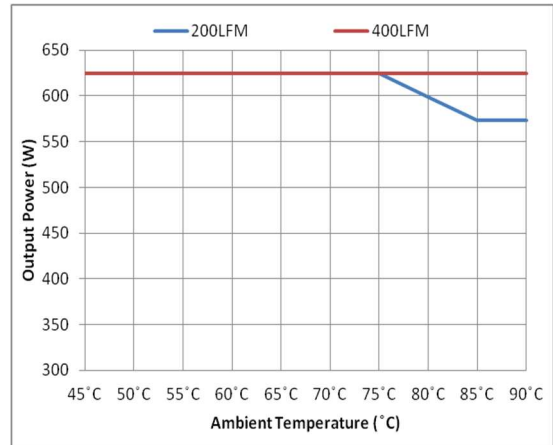

Figure 15 Thermal De-rating Data of Base-plate module with 0.61" Heat-sink

Test at 50V_{in}, longitudinal airflow from V_{in} to V_{out}

ENVIRONMENTAL SPECIFICATIONS

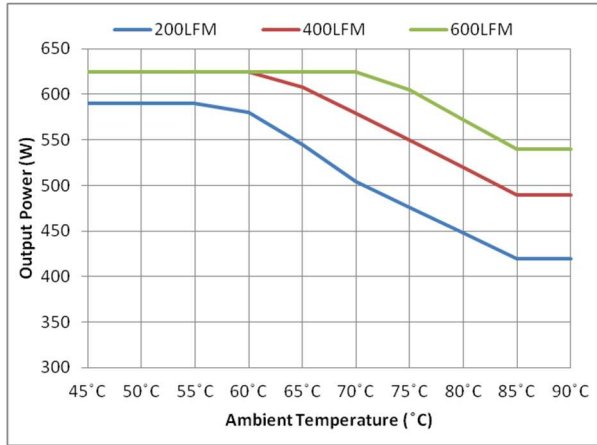

Figure 16 Thermal De-rating Data of Open-frame module
 Test at 56V_{in}, longitudinal airflow from V_{in} to V_{out}

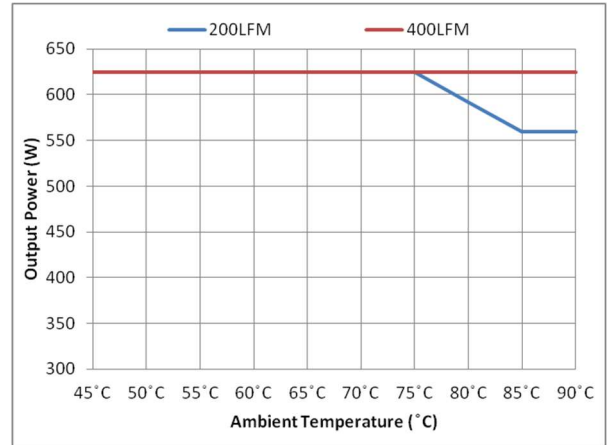

Figure 17 Thermal De-rating Data of Base-plate module with 0.61" Heat-sink
 Test at 56V_{in}, longitudinal airflow from V_{in} to V_{out}

ENVIRONMENTAL SPECIFICATIONS

Open-frame unit and Base-plate unit longitudinal Thermal De-rating data

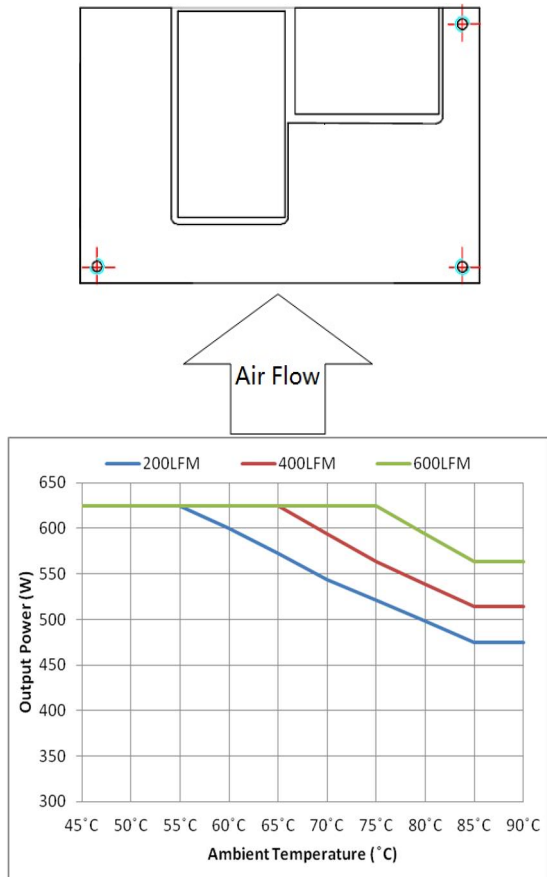

Figure 18 Thermal De-rating Data of Open-frame module

Test at 45V_{in}, longitudinal airflow from V_{in-} to V_{in+}

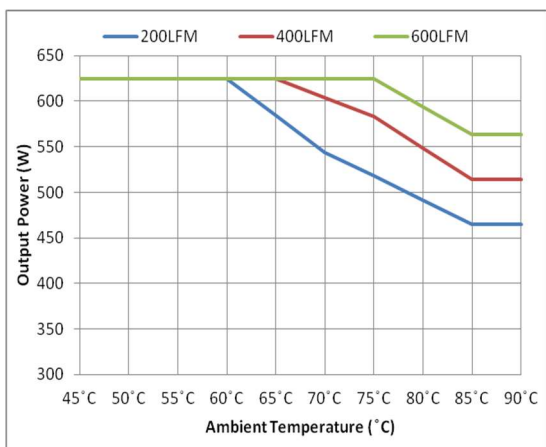

Figure 20 Thermal De-rating Data of Open-frame module

Test at 50V_{in}, longitudinal airflow from V_{in-} to V_{in+}

Base-plate unit with 0.61" heat-sink longitudinal Thermal De-rating data

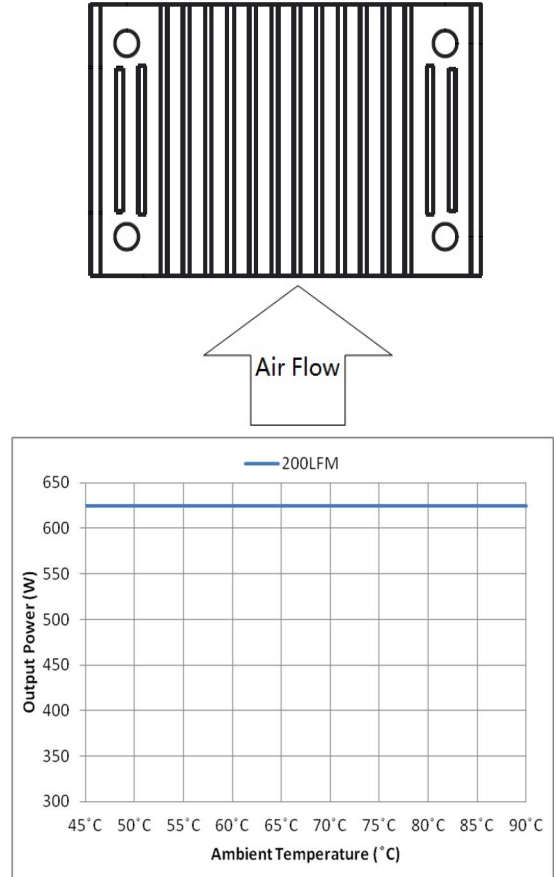

Figure 19 Thermal De-rating Data of Base-plate module with 0.61" Heat-sink

Test at 45V_{in}, longitudinal airflow from V_{in-} to V_{in+}

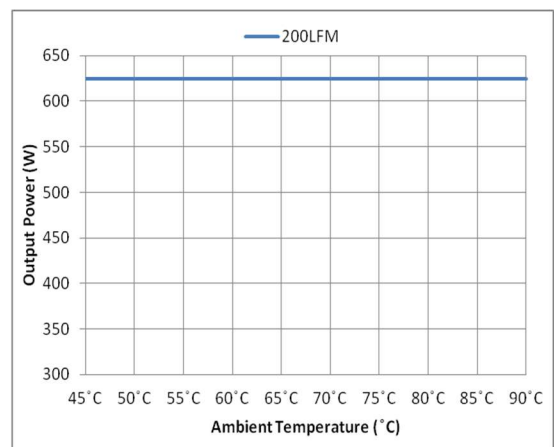

Figure 21 Thermal De-rating Data of Base-plate module with 0.61" Heat-sink

Test at 50V_{in}, longitudinal airflow from V_{in-} to V_{in+}

ENVIRONMENTAL SPECIFICATIONS

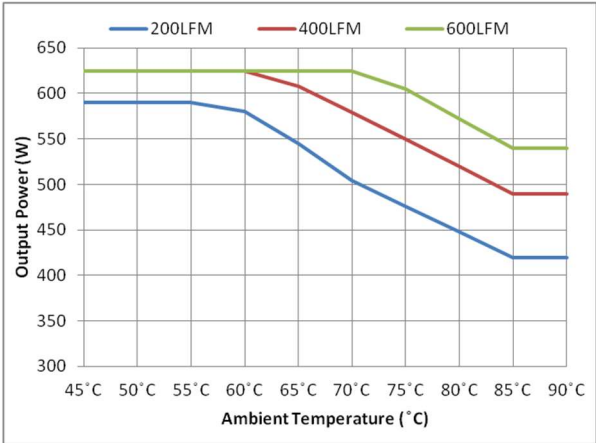

Figure 22 Thermal De-rating Data of Open-frame module
Test at 56Vin, longitudinal airflow from Vin- to Vin+

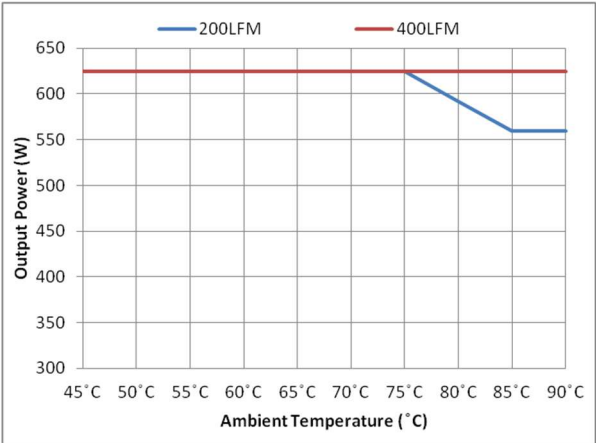

Figure 23 Thermal De-rating Data of Base-plate module with 0.61" Heat-sink
Test at 56Vin, longitudinal airflow from Vin- to Vin+

The thermal data presented here is based on physical measurements taken in a wind tunnel to monitor key component temperatures: FETs, diodes, control ICs, magnetic cores, ceramic capacitors, and opto-isolators, while controlling the ambient airflow rate and temperature. For a given airflow and ambient temperature, the module output power is increased, until one (or more) of the components reaches its maximum de-rated operating temperature, as defined in IPC-9592B. This procedure is then repeated for a different airflow or ambient temperature until a family of module output de-rating curves is obtained.

Note: Temperatures between 85 °C and 90 °C are Short-Term Operating. Under these conditions, the following applies: For the conditions where airflow is between 200 LFM and 400 LFM only, airflow will increase by 150 LFM Unit's component temperatures are allowed to exceed IPC-9592B guidelines but not exceed component temperature ratings. The Unit may be subjected to this condition for a maximum of 96 hours per year.

ENVIRONMENTAL SPECIFICATIONS

Qualification Testing

Table 7. Qualification testing		
Parameter	Unit (pcs)	Test condition
Halt test	16pcs Open-frame 4pcs base-plate	IPC9592B section 5.2.3 & EDCS-617316 section 6.14
Operating Random Vibration	3pcs open-frame 3pcs base-plate	Frequency range: 10, 30-200, 500 PSD (g ² /Hz): 0.001, 0.02, 0.002 Acceleration: 2.4grms axes of vibration: X/Y/Z; Time: 30min/axis
Non-operating Random Vibration	3pcs open-frame 3pcs base-plate	Frequency range: 5-200, 500 PSD (g ² /Hz): 0.052, 0.003 Acceleration: 3.8grms axes of vibration: X/Y/Z; Time: 30min/axis
Operating Half Sine Shock	3pcs open-frame 3pcs base-plate	30g, 11ms, 3 shocks in each of 3 axes
Temperature Cycles	15pcs open-frame 15pcs base-plate	-40 °C to 125 °C, 700 cycles, Dwell time at each temperature limit: 30min, temperature change rate: 5 °C/min to 20°C/min.
Power Temperature Cycle	3pcs open-frame 3pcs base-plate	-5 °C to 85 °C, 300 unit-cycles, max rated line, half rated load. Dwell time at each temperature limit: 30min
Temperature Humidity Bias	15pcs open-frame 15pcs base-plate	72hrs 85 °C, 85%RH, unpowered pre-conditioning soak; 1000hrs 85 °C, 85%RH, max rated line, min rated load.
Solder ability	15pcs	IPC J-STD-002C-2007

APPLICATION NOTES

Typical Application

Below is the typical application of the ADQ600-48S10-4L series power supply.

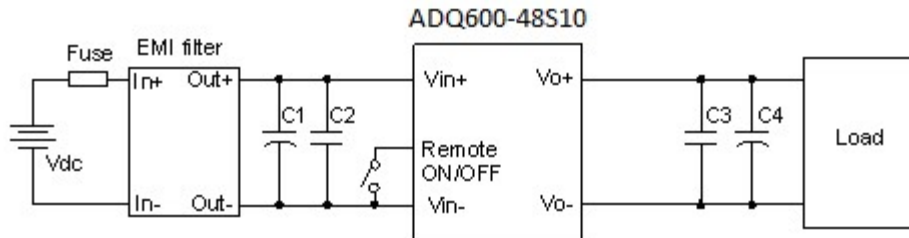

Figure 24 Typical application

C1: 330 μ F/100V electrolytic capacitor, P/N: UPM2A331MPD (Nichicon) or equivalent caps

C2: 1 μ F/100V X7R ceramic capacitor,

C3: 22 μ F/16V/X7S capacitor, 14PCS in parallel

C4: 1000 μ F/25V electrolytic capacitor, P/N: OSK or POSCAP

Fuse: External fast blow fuse with a rating of 25A/250Vac. The recommended fuse model is 0314025.P from Karwin Tech limited.

EMI filter: refer to U1 in Figure 28

APPLICATION NOTES

Remote ON/OFF

Negative remote ON/OFF logic is available in ADQ600-48S10-4L. The logic is CMOS and TTL compatible. Remote ON/OFF (ENABLE) can be controlled by an external switch between the on/off terminal and the V_{in-} terminal. The switch can be an open collector or open drain. The voltage between pin Remote ON/OFF and pin V_{in-} must not exceed the range listed in table "Feature characteristics" to ensure proper operation. The external Remote ON/OFF circuit is highly recommended as shown in figure 28. For the negative logic, if the remote ON/OFF (ENABLE) feature is not used, please maintain the ENABLE pin to V_{in-} .

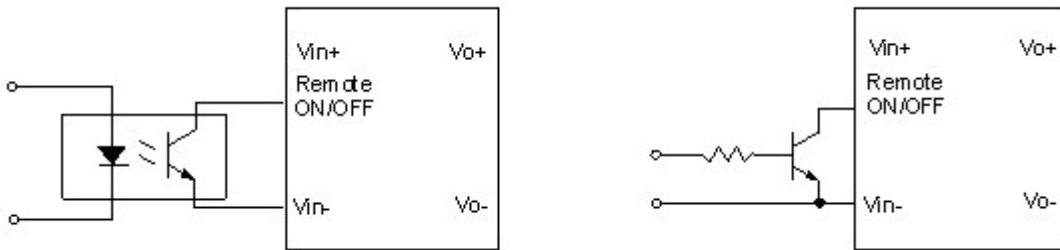

Figure 25 Typical application

APPLICATION NOTES

Parallel and Droop Current Sharing

The modules are capable of operating in parallel, and realizing current sharing by droop current sharing method. There is approximately 400mV output voltage droop from 0A to full output Load, and there is no current sharing pin. By connecting the Input pins and the Output pins of the parallel module together, the current sharing can be realized automatically.

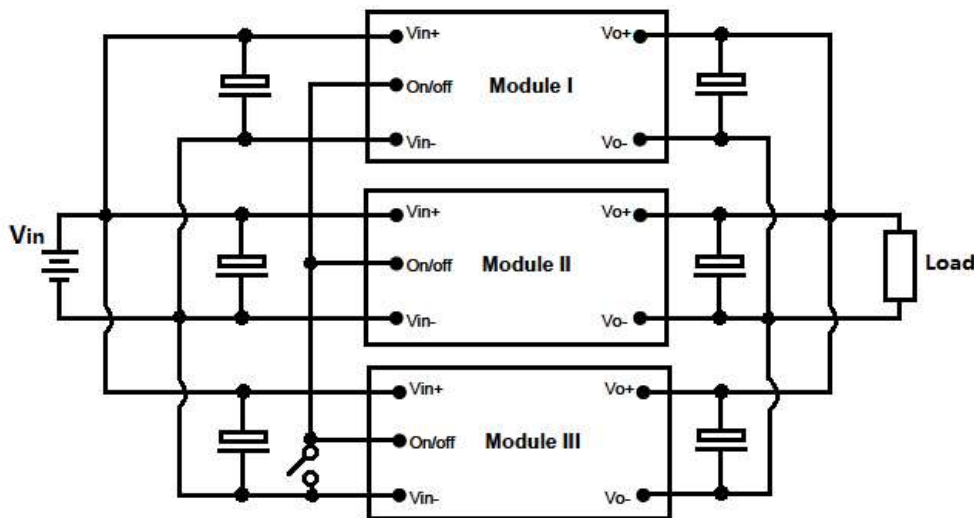

Figure 26 Parallel and droop current sharing configuration for when no redundancy requirement system

If system has no redundancy requirement, the modules can be connected in parallel directly for higher power without adding external Oring-fet; whereas, If the redundancy function is required, external Oring-fet should be added.

1. To ensure a better current sharing accuracy, The design guidelines below should be followed:
 - a) The inputs of the converters must be connected to the same voltage source; and the PCB trace resistance from Input voltage source to V_{in+} and V_{in-} of each converter should be equalized as much as possible.
 - b) The PCB trace resistance from each converter's output to the load should be equalized as much as possible.
 - c) When testing the accuracy of the current sharing function, the module should be soldered into the host PCB order to avoid the unbalance of the contact resistance between the modules to the host board.
2. The input voltage must remain between 45Vdc and 56Vdc for droop sharing to be functional.
3. It is advised to use a common Remote On/Off signal to start all modules in parallel.
4. Modules in parallel condition may automatically increase the Turn On delay, as specified in the "Dynamic characteristics" Table, if output voltage is present on the output bus at startup.
5. When parallel modules startup into a pre-biased output, e.g. partially discharged output capacitance, the Rise time is automatically increased, as specified in the "Dynamic characteristics" Table, to insure a monotonic and smooth startup.
6. Insure that the total load is <50% $I_{o,max}$ (for a single module) until all parallel modules have started (load full start > module Tdelay time max + Trise time).
7. If fault tolerance is desired in parallel applications, output ORing devices should be used to prevent a single module failure from collapsing the load bus.

APPLICATION NOTES

Input Ripple & Output Ripple & Noise Test Configuration

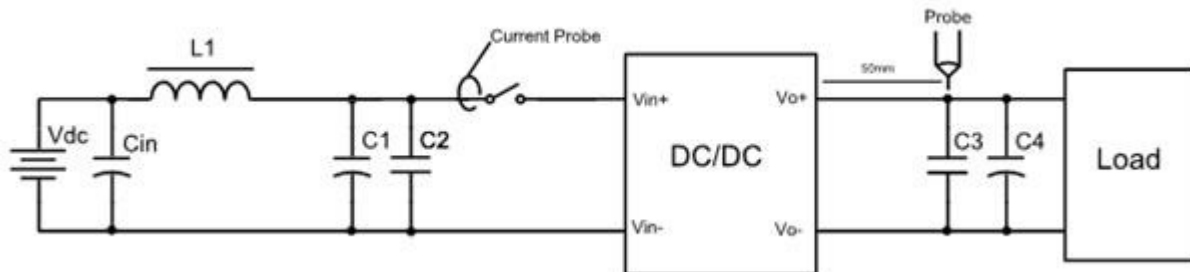

Figure 27 Input ripple & inrush current & ripple and noise test configuration

Vdc: DC power supply

L1 < 500 μ H

Cin: 220 μ F/100V typical

C1: 1 μ F/100V/X7R capacitor

C2: 600 μ F/100V/ electrolytic capacitor,

C3: 14PCS 22 μ F/16V/X7S capacitor

C4: 330 μ F/25V + 120 μ F/25V OSCON capacitor

Note - Using a coaxial cable with series 50ohm resistor and 0.68 μ F ceramic capacitor or a ground ring of probe to test output ripple & noise is recommended.

APPLICATION NOTES

EMC Test Conditions

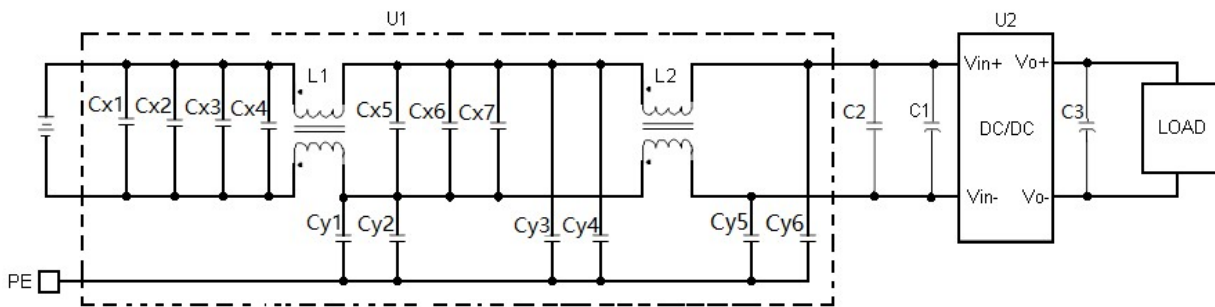

Figure 28 EMC test conditions

C1: 470 μ F/100V electrolytic capacitor, P/N: UPM2A471MPD (Nichicon) or equivalent caps

C2: 0.1 μ F/100V/X7R capacitor

C3: 330 μ F/25V OSCON or POSCAP, 2PCS in parallel

U1: Input EMC filter

U2: Module to test, ADQ600-48S10-4L

CX1, CX2, CX3, CX4, CX5, CX6, CX7: 1 μ F/100V/X7R capacitor

Cy1, Cy2, Cy3, Cy4: 0.22 μ F/630V/X7R Y capacitor, 2Pcs in parallel

Cy5, Cy6, 0.22 μ F/630V/X7R Y capacitor

L1, L2: 473 μ H, common mode inductor.

Fuse: External fast blow fuse with a rating of 25A/250Vac. The recommended fuse model is 0314025.P from Karwin Tech limited.

SOLDERING INFORMATION

Soldering

Generally, as the most common mass soldering method for the solder attachment, wave soldering is used for through-hole power modules and reflow soldering is used for surface-mount ones.

Reflow soldering is not a suggested method for through-hole power modules due to process challenges that can result in reduced module reliability. If you have this kind of application requirement, please contact sales or FAE for further information and recommendations.

Wave Soldering

When wave soldering is used, the temperature on pins is specified to maximum 255 °C for maximum 7s.

When manual soldering is used, the iron temperature should be maintained at 300 °C ~ 380 °C and applied to the converter pins for less than 10s. Longer exposure can cause internal damage to the converter.

Cleaning of solder joint can be performed with cleaning solvent IPA or simulative.

Reflow Soldering

High temperature and long soldering time will result in IMC layer increasing in thickness and thereby shorten the solder joint lifetime. Therefore the peak temperature over 245 °C is not suggested due to the potential reliability risk of components under continuous high-temperature. In the meanwhile, the soldering time of temperature above 217 °C should be less than 90 seconds.

Please refer to following fig for recommended temperature profile parameters.

Shielding cap is requested to mount on DCDC module if with heat-spreader/heat-sink, to prevent the customer side high temperature of reflow to re-melt the DCDC module's internal component's soldering joint.

RECORD OF REVISION AND CHANGES

Issue	Date	Description	Originators
1.0	02.02.2016	First Issue	K. Wang
1.1	03.21.2016	Add a tolerance	K. Wang
1.2	12.03.2019	Update the soldering information	K. Wang
1.3	04.09.2021	Add note for screw depth in mechanical part	V. Guo
1.4	05.20.2022	Add UKCA Mark	J.Zhang



For international contact information,
visit advancedenergy.com.

powersales@aei.com (Sales Support)
productsupport.ep@aei.com (Technical Support)
+1 888 412 7832

ABOUT ADVANCED ENERGY

Advanced Energy (AE) has devoted more than three decades to perfecting power for its global customers. AE designs and manufactures highly engineered, precision power conversion, measurement and control solutions for mission-critical applications and processes.

Our products enable customer innovation in complex applications for a wide range of industries including semiconductor equipment, industrial, manufacturing, telecommunications, data center computing, and medical. With deep applications know-how and responsive service and support across the globe, we build collaborative partnerships to meet rapid technological developments, propel growth for our customers, and innovate the future of power.

PRECISION | POWER | PERFORMANCE

Specifications are subject to change without notice. Not responsible for errors or omissions. ©2020 Advanced Energy Industries, Inc. All rights reserved. Advanced Energy®, and AE® are U.S. trademarks of Advanced Energy Industries, Inc.